

# Harman Kardon AVR80II Audio/Video Receiver



## Owner's Manual

harman/kardon

# Owner's Manual

## AVR80// Audio/Video Receiver

### Table of Contents

Introduction .....	1
Features .....	1
Safety Information .....	2-3
Unpacking and Installation .....	3
Conventions .....	3
Front Panel Controls .....	4-5
Front Panel Information Display .....	6-7
Rear Panel Audio & Systems Connections .....	8-9
Rear Panel Video Connections .....	10-11
Remote Control Functions .....	12-13
Installation, Set Up and Configuration .....	14-16
Remote Control Programming and Operation .....	17-18
System Configuration .....	19-22
Basic Operation .....	23-26
Source Selection .....	23
Volume Control .....	23
Surround Mode Selection .....	23
TV Auto On Function .....	24
Tuner Operation .....	24-26
On Screen Display .....	27-29
Advanced Functions .....	30-32
Audio Tape Dubbing .....	30
Video Dubbing .....	30
Audio/Video Simulcast Recording .....	30
Delay Time Adjust .....	30-31
Direct Digital Decoding .....	31
6 Channel Direct Operation .....	31
Surround Mode Chart .....	32
Multiroom Operation .....	33-35
System Reset .....	35
Troubleshooting Chart .....	36
Technical Specifications .....	37

# Introduction

**Congratulations!** With the purchase of a Harman Kardon AVR80// you are about to begin many years of listening enjoyment. The AVR80// has been custom designed to provide all the excitement and detail of movie soundtracks and every subtle nuance of musical selections. In addition, the AVR80// has the flexibility to expand to serve as the heart of a multiroom audio system, and the capability for use with digital multi-channel audio systems.

While complex digital systems are hard at work within the AVR80// to make all of this happen, hook-up and operation are simple. Color keyed connections, a comprehensive remote control and on screen menus make the AVR80// easy to use. To obtain the maximum enjoyment from your new receiver we urge you to take a few minutes to read through this manual. This will ensure that connections to speakers, source playback units and other external devices are made properly. In addition, a few minutes spent learning the functions of the various controls will enable you to take advantage of all the power the AVR80// is able to deliver.

If you have any questions about this product, its installation or operation, please contact your retailer or custom installer. They are your best local source of information.

## Description and Features

The AVR80// is a full featured A/V receiver, incorporating a wide variety of listening options. In addition to standard Dolby® Pro Logic™ processing, the AVR80// uses Twin Digital Signal Processors to provide Home THX® Cinema and five other surround modes. Expansion capability enables upgrades to 5.1 digital audio systems such as AC-3™ through the use of an optional external adapter.

A total of five audio/video inputs, each with both composite and “S” video, as well as three additional audio only inputs are selected through a learning remote control and an easy to read front panel display or on screen graphics through a TV monitor. Dubbing and tape outputs are available, and multiroom operation is available with independent source and volume selection.

The AVR80//’s powerful amplifier uses traditional Harman Kardon High Current design philosophies to meet the wide dynamic range of any program selection. For the audio purist, the AVR80// may be connected directly to the digital output of an LD player, avoiding excessive D/A conversion steps.

Harman Kardon invented the high fidelity receiver over forty years ago. With state of the art circuitry and time honored circuit designs, the AVR80// is undoubtedly the finest receiver ever offered by Harman Kardon.

- Twin DSP processors for precise surround decoding
- Dolby ProLogic, Home THX Cinema, Dolby 3 Stereo and three other surround modes
- On screen menu displays
- Learning remote control
- Composite and “S” video switching
- Complete Multiroom control
- Direct Digital Input from LD
- Preamp output/Amplifier input of ALL channels permits ease of expansion
- Six Channel Direct inputs for use with external discrete digital audio adapters

# Safety Information

2

## Important Safety Information

### Verify Line Voltage Before Use

Your AVR80// has been designed for use with 120 volt AC current. Connection to a line voltage other than that for which it is intended can create a safety and fire hazard, and may damage the unit.

If you have any questions about the voltage requirements for your specific model, or about the line voltage in your area, contact your selling dealer before plugging the unit into a wall outlet.

### Do Not Use Extension Cords

To avoid safety hazards, use only the power cord attached to your unit. We do not recommend that extension cords be used with this product. As with all electrical devices, do not run power cords under rugs or carpets or place heavy objects on them. Damaged power cords should be replaced immediately with cords meeting factory specifications.

### Handle the AC Power Cord Gently

When disconnecting the power cord from an AC outlet, always pull the plug, never pull the cord. If you do not intend to use the unit for any considerable length of time, disconnect the plug from the AC outlet.

### Do Not Open The Cabinet

There are no user serviceable components inside this product. Opening the cabinet may present a shock hazard, and any modification to the product will void your guarantee. If water or any metal object such as a paper clip, wire or a staple accidentally falls inside the unit, disconnect it from the AC power source immediately, and consult an authorized service station.

### CATV or Antenna Grounding

If an outside antenna or cable system is connected to this product, be certain that it is grounded so as to provide some protection against voltage surges and static charges. Section 810 of the National Electrical Code, ANSI/NFPA No. 70-1984, provides information with respect to proper grounding of the mast and supporting structure, grounding of the lead-in wire to an antenna discharge unit, size of grounding conductors, location of antenna discharge unit, connection to grounding electrodes and requirements of the grounding electrode.

### NOTE TO CATV SYSTEM INSTALLER:

This reminder is provided to call the CATV (Cable TV) system installer's attention to article 820-40 of the NEC that provides guidelines for proper grounding and, in particular, specifies that the cable ground shall be connected to the grounding system of the building, as close to the point of cable entry as possible.

### Installation Location

- To assure proper operation, and to avoid the potential for safety hazards, place the unit on a firm and level surface. When placing the unit on a shelf, be certain that the shelf and any mounting hardware can support the weight of the product.
- Make certain that proper space is provided both above and below the unit for ventilation. If this product will be installed in a cabinet or other enclosed area, make certain that there is sufficient air movement within the cabinet. Under some circumstances a fan may be required.
- Do not place the unit directly on a carpeted surface.
- Avoid installation in extremely hot or cold locations, or an area that is exposed to direct sunlight or heating equipment.
- Avoid moist or humid locations.
- Do not obstruct the ventilation slots on the top of the unit, or place objects directly over them.



**CAUTION**  
RISK OF ELECTRICAL SHOCK  
DO NOT OPEN



**CAUTION: TO REDUCE THE RISK OF ELECTRIC SHOCK, DO NOT REMOVE COVER (OR BACK). NO USER-SERVICEABLE PARTS INSIDE. REFER SERVICING TO QUALIFIED SERVICE PERSONNEL.**



The lightning flash with arrowhead symbol, within an equilateral triangle, is intended to alert the user to the presence of uninsulated "dangerous voltage" within the product's enclosure that may be of sufficient magnitude to constitute a risk of electric shock to persons.



The exclamation point within an equilateral triangle is intended to alert the user to the presence of important operating and maintenance (servicing) instructions in the literature accompanying the appliance.

**WARNING: TO REDUCE THE RISK OF FIRE OR ELECTRIC SHOCK, DO NOT EXPOSE THIS APPLIANCE TO RAIN OR MOISTURE.**

**CAUTION: TO PREVENT ELECTRIC SHOCK, MATCH WIDE BLADE OF PLUG TO WIDE SLOT. FULLY INSERT.**

**ATTENTION: POUR EVITER LES CHOCS ELECTRIQUES, INTRODUIRE LA LAME LA PLUS LARGE DE LA FICHE DANS LA BORNE CORRESPONDANTE DE LA PRISE ET POUSSER JUSQU'AU FOND.**

# Safety Information

## Cleaning

When the unit gets dirty, wipe it with a clean, soft dry cloth. If necessary, wipe it with a soft cloth dampened with mild soapy water, then a fresh cloth with clean water. Wipe dry immediately with a dry cloth. NEVER use benzene, aerosol cleaners, thinner, alcohol or any other volatile cleaning agent. Do not use abrasive cleaners, as they may damage the finish of metal parts. Avoid spraying insecticide near the unit.

## Moving The Unit

Before moving the unit, be certain to disconnect any interconnection cords with other components, and make certain that you disconnect the unit from the AC outlet.

## Important information for the user

**NOTE:** This equipment has been tested and found to comply with the limits for a Class B digital device, pursuant to Part 15 of the FCC Rules. The limits are designed to provide reasonable protection against harmful interference in a residential installation. This equipment generates, uses and can radiate radio frequency energy and, if not installed and used in accordance with the instructions, may cause harmful interference to radio communication. However, there is no guarantee that harmful interference will not occur in a particular installation. If this equipment does cause harmful interference to radio or television reception, which can be determined by tuning the equipment off and on, the user is encouraged to try to correct the interference by one or more of the following measures:

- Reorient or relocate the receiving antenna.
- Increase the separation between the equipment and receiver.
- Connect the equipment into an outlet on a circuit different from that to which the receiver is connected.
- Consult the dealer or an experienced radio/TV technician for help.

This device complies with Part 15 of the FCC Rules. Operation is subject to the following two conditions: (1) this device may not cause harmful interference, and (2) this device must accept interference received, including interference that may cause undesired operation.

**NOTE:** Changes or modifications may cause this unit to fail to comply with Part 15 of the FCC Rules and may void the user's authority to operate the equipment.

## Unpacking and Installation

The carton and shipping materials used to protect your new receiver during shipment were specially designed to cushion it from shock and vibration. We suggest that you save the carton and packing materials for use in shipping if you move or should the unit ever need repair.

To minimize the size of the carton in storage, you may wish to flatten it. This is done by carefully slitting the tape seams on the bottom and collapsing the carton down to a more two dimensional appearance. Other cardboard inserts may be stored in the same manner. Packing materials that cannot be collapsed should be saved along with the carton in a plastic bag.

If you do not wish to save the packaging materials, please note that the carton and other sections of the shipping protection are recyclable. Please respect the environment and discard those materials at a local recycling center.

## Conventions

In order to help you use this manual with the remote control, front panel controls, rear panel connections and on-screen menus, certain conventions have been used.

**EXAMPLE** – (bold type) indicates a specific remote control or front panel button, or rear panel connection jack

**EXAMPLE** – (OCR type) indicates a message that is visible through the on-screen menu system

**1** – (number in a square) indicates a specific front panel control

① – (number in a circle) indicates an indicator in the main front panel display

① – (number in an oval) indicates a button or indicator on the remote

**A** – (letter in a circle) indicates a rear panel Audio or System connection

**A** – (letter in a square) indicates a specific rear panel video connection

# Front Panel Controls

4

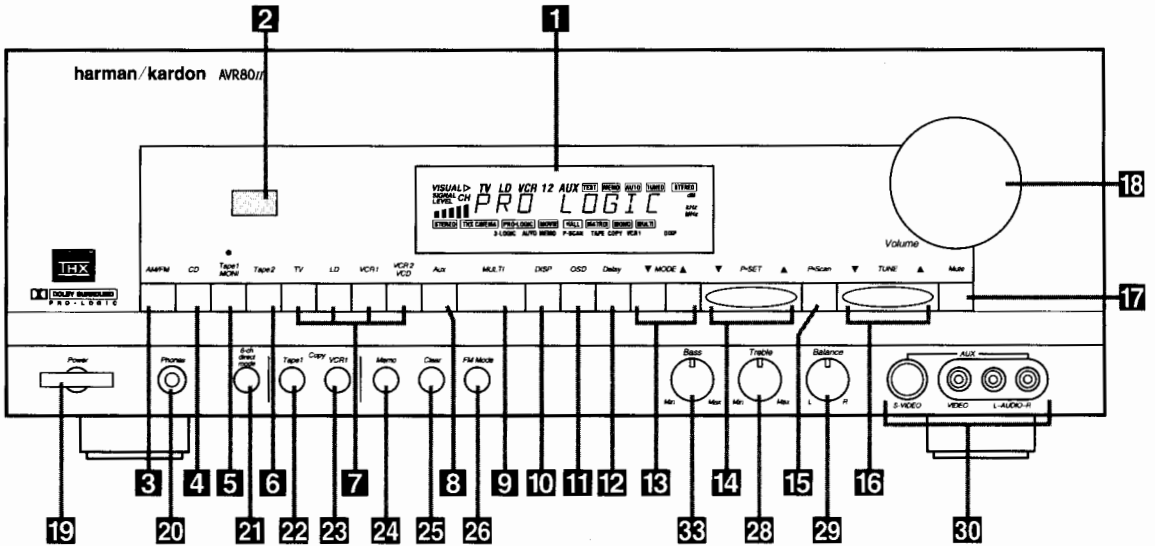

- |                                     |                                   |                              |
|-------------------------------------|-----------------------------------|------------------------------|
| <b>1</b> Information display        | <b>11</b> OSD (On Screen Display) | <b>21</b> 6 Channel Direct   |
| <b>2</b> Remote Sensor Window       | <b>12</b> Delay                   | <b>22</b> Tape 1 Copy        |
| <b>3</b> AM/FM Tuner Mode Selection | <b>13</b> Mode                    | <b>23</b> VCR 1 Copy         |
| <b>4</b> CD                         | <b>14</b> Preset Tuning           | <b>24</b> Memo               |
| <b>5</b> Tape1/Monitor              | <b>15</b> P-Scan                  | <b>25</b> Clear              |
| <b>6</b> Tape 2                     | <b>16</b> Tune                    | <b>26</b> FM Mode            |
| <b>7</b> Video Sources              | <b>17</b> Mute                    | <b>27</b> Bass               |
| <b>8</b> Aux                        | <b>18</b> Volume Control          | <b>28</b> Treble             |
| <b>9</b> Multiroom Audio Select     | <b>19</b> Power                   | <b>29</b> Balance            |
| <b>10</b> Display                   | <b>20</b> Headphone Jack          | <b>30</b> Front Panel Inputs |

# Front Panel Controls

5

**1 Fluorescent display:** This display delivers messages and status indications to help you operate the receiver. Refer to the separate diagram for complete explanation of the FL display.

**2 Remote Sensor Window:** The sensor behind this window receives infrared signals from the remote control. Aim the remote at this area and do not block or cover it unless an external remote sensor is installed.

**3 AM/FM Tuner Mode Selection:** Press this button once to select the tuner. Press it again to switch between AM and FM.

**4 CD:** Press this button to select the CD player.

**5 Tape1/Monitor:** Press this button to select Tape One as the input source. A red LED above the button will illuminate to indicate that the Tape Monitor has been selected.

**6 Tape 2:** Press this button to select Tape 2.

**7 Video Sources:** Press any of these buttons to select a video input source.

**8 Aux:** Press this button to select the source connected to the front panel **Aux** jacks.

**9 Multiroom Audio Select:** Press this button to turn on the feed to the remote zone. The remote zone will stay on after the main power switch is tuned off until it is switched off by the remote room control or by pressing this button again.

**10 Display:** Press this button to turn off the front panel FL display. The **DISP** indicator will illuminate to remind you that the unit is still turned on.

**11 OSD (On Screen Display):** Press the button briefly to display a system status report on your video screen.

**12 Delay:** Press this button to increase the delay to the rear (surround) channels.

**13 Mode:** Press these buttons to scroll up ▲ or down ▼ through the list of available surround modes.

**14 P-Set:** Press these buttons to manually scroll up ▲ or down ▼ through the FM or AM stations programmed into the receiver's preset memory.

**15 P-Scan:** Press this button to automatically scan through the FM or AM stations preset into the receiver's memory. Press the button again to stop the scan when the tuner is at the desired station.

**16 Tune:** Press these buttons to manually scan up ▲ or down ▼ through the FM or AM bands.

**17 Mute:** Press this button to cut the output to the speakers. Press it again to return to the previous volume level.

**18 Volume Control:** Turn the knob clockwise to increase volume, counterclockwise to decrease the volume. Note that approximately two revolutions of the knob are required to go from no output to maximum volume.

**19 Power:** Press this button once to turn the unit on or off. In order to use the remote control to turn the unit on the power switch must be pressed once, and then the unit must be turned off via the remote.

**20 Headphone Jack:** Plug standard stereo headphones into this jack for private listening.

**NOTE:** When the headphones are in use the output to the speakers is muted and the surround mode is automatically switched to **STEREO**. When the headphones are removed from the jack, sound to the speakers is restored and the unit returns to the previous sound mode.

**21 6 Channel Direct:** Press this button to select the output of an external multichannel audio adapter.

**22 Tape 1 Copy:** Press this button to select the input for the recorder connected to **Tape 1**. The first press will select the source currently being listened to. Press again to select the input in the following order:  
**Tuner** → **CD** → **Tape 2** → **Source**.

**23 VCR 1 Copy:** Press this button to select the input to the recorder connected to VCR 1. The first press selects the input currently being viewed. Press the button again to select the input in the following order:  
**TV** → **LD** → **VCR 2** → **AUX** → **Source**

**24 Memo:** The memo button is used to enter stations to the tuner's preset memory in either the manual or automatic modes. It is also used clearing the memory and when changing the TV auto on-mode.

**25 Clear:** The clear button is used to cancel tuning, memory input or when clearing the unit's memories.

**26 FM Mode:** Press this button to select the tuning mode for FM stations.

**27 Bass:** This knob adjusts the tone of low frequency sounds. Turn it to the right to boost bass frequencies or to the left to cut bass frequencies.

**28 Treble:** This knob adjusts the tone of high frequency sounds. Turn it to the right to boost high frequencies or to the left to cut high frequencies.

**29 Balance:** This knob adjusts the balance between the front left and right speakers.

**30 Front Panel Inputs:** Audio or Video sources connected to these jacks may be selected by pressing the **Aux** button **8**.

# Front Panel Information Display

6

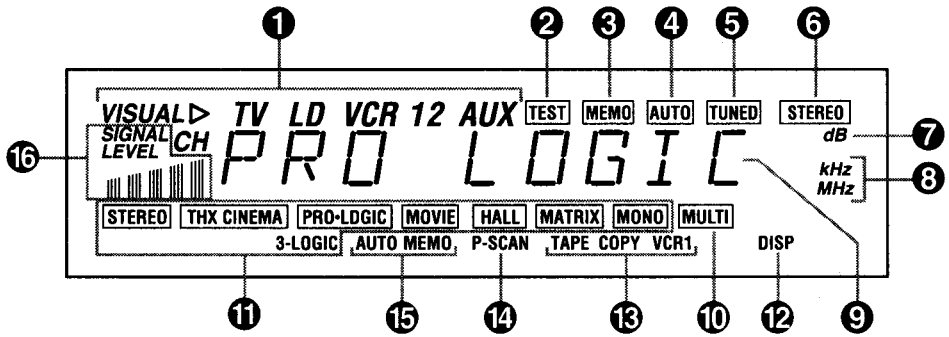

① "Visual" Indicators

- ② Test
- ③ Memo
- ④ Auto
- ⑤ Tuned
- ⑥ Stereo

⑦ Volume Indication

- ⑧ Tuner Frequency Indication
- ⑨ Main Information Display
- ⑩ Multi
- ⑪ Mode Status
- ⑫ DISP

⑬ Copy Indicators

- ⑭ P-Scan
- ⑮ Auto Memo
- ⑯ Signal Level Indication



# Front Panel Information Display

7

**1 "Visual" Indicator:** These indicators display which input source is being fed to the video monitor output.

**2 Test:** This indicator flashes when the output levels are being set using the built in test signal generator.

**3 Memo:** This indicator flashes when the **Memo** button is pressed when entering presets and other information into the tuner's memory.

**4 Auto:** This indicator signifies that the Automatic Tuning mode is in use for FM broadcasts.

**5 Tuned:** This indicator lights when an AM or FM station is properly tuned and locked.

**6 Stereo:** This indicator lights when an FM station is broadcasting in stereo.

**7 Volume indication:** The last two indicators on the information display indicate the volume level. Note that **0dB** is the reference level, not an indication that there is no output.

**8 Tuner Frequency Indication:** When the tuner is in use, the main Information Display will show the preset channel number, if any, the frequency band and the station frequency. Indicators at the right side of the display show **kHz** when an AM station is tuned or **MHz** when an FM station is tuned.

**9 Main Information Display:** This ten digit display shows messages relating to the status, input source, surround mode, tuner, volume level or other aspects of unit's operation.

**10 Multi:** This indicator signifies that the AVR80// is sending a program source to a remote room location. Note that it may be illuminated even when the unit is "off" in the main listening room, signifying that operation continues at another location. When a remote command is being received via the **Multi** IR connection, this indicator will flash.

**11 Mode Status:** These indicators display the currently selected surround mode.

**12 DISP:** This indicator lights when the FL display has been turned off using the **Display** button **10** to remind you that the unit is still turned on.

**13 Copy Indicators:** The **TAPE COPY** indicator lights when an input other than the current source has been selected to copy Tape 1. The **VCR COPY 1** indicator signifies that the input to VCR 1 is other than the currently selected source.

**14 P-Scan:** This indicator flashes when the stations programmed into the tuner memory are being automatically reviewed.

**15 Auto Memo:** This indicator flashes when the tuner is automatically scanning for stations and entering them into the preset memory.

**16 Signal Level Indication:** This is a visual indication of the strength of a radio station signal. The more bars visible, the stronger the station.

# Rear Panel Audio and System Connections

8

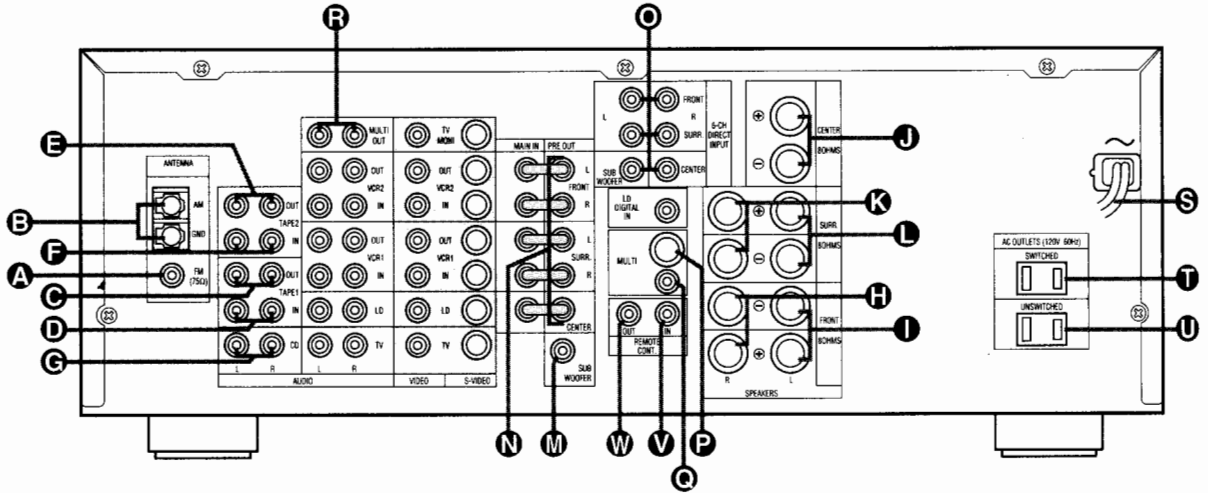

- A** FM Antenna
- B** AM Antenna
- C** Tape 1 Out
- D** Tape 1 In
- E** Tape 2 Out
- F** Tape 2 In
- G** CD IN
- H** Front Right Speaker Output

- I** Front Left Speaker Output
- J** Center
- K** Surround Right Speaker Output
- L** Surround Left Speaker Output
- M** Subwoofer Pre-Out
- N** Pre-Outs
- O** 6 Channel Direct Input
- P** Multi Room Interface

- Q** Multi IR
- R** Multi-Out
- S** Power Cable
- T** Switched AC Outlet
- U** Unswitched AC Outlet
- V** Remote IR In
- W** Remote IR Out

# Rear Panel Audio and System Connections

9

**A FM Antenna:** Connect an indoor or external FM antenna to these terminals.

**B AM Antenna:** Connect the AM loop antenna supplied with the receiver to these terminals. If an external AM antenna is used, make connections to the **AM** and **GND** terminals in accordance with the instructions supplied with the antenna.

**C Tape 1 Out:** Connect these jacks to the RECORD/INPUT jacks of an audio recorder.

**D Tape 1 In:** Connect these jacks to the PLAY/OUT jacks of an audio recorder.

**E Tape 2 Out:** Connect these jacks to the RECORD/INPUT jacks of a second audio recorder.

**F Tape 2 In:** Connect these jacks to the PLAY/OUT jacks of a second audio recorder.

**G CD IN:** Connect these jacks to the output of a compact disc player or CD changer.

**H Front R:** Connect these terminals to the front right speaker.

**I Front L:** Connect these terminals to the front left speaker.

**J Center:** Connect these terminals to the center speaker.

**K Surround R:** Connect these terminals to the right surround speaker.

**L Surround L:** Connect these terminals to the left surround speaker.

**M Subwoofer Pre-Out:** Connect this jack to the line level input of a powered subwoofer. If an external subwoofer amplifier is used, connect this jack to the subwoofer amplifier input.

**N Pre-Outs:** If external power amplifiers are used for any channels, remove the jumper pin and connect the jack to the input of the amplifier.

**O 6 Channel Direct Input:** If an external digital audio decoder is used for 5.1 (Dolby Digital) audio, connect the outputs of that decoder to these terminals.

**P Multi Room Interface:** For multi-room installations where keypad remotes are in use, connect the keypad interface to this jack.

**Q Multi IR:** Connect the output of an IR sensor in a remote room to this jack to operate the AVR80//s multi-room control system.

**R Multi-Out:** When using the AVR80// for multi-room audio, connect this jack to the input of the audio amplifier powering the remote room speakers.

**S Power Cable:** Connect the AC plug to a non-switched AC wall output.

**T Switched AC Outlet:** This outlet may be used to power any device that you wish to have on when the unit is turned on.

**U Unswitched AC Outlet:** This outlet may be used to power any AC device. The power will remain on at this outlet regardless of whether the AVR80// is on or off.

**V Remote IR In:** If the AVR80//s front panel IR sensor is blocked due to cabinet doors or other obstructions, an external IR sensor may be used. Connect the output of the sensor to this jack.

**W Remote IR Out:** This connection permits the IR sensor in the receiver to serve other remote controlled devices. Connect this jack to the "IR IN" jack on Harman Kardon or other compatible equipment.

**NOTE:** The power consumption of the device plugged into each of these outlets should not exceed 120 watts.

# Rear Panel Video Connections

10

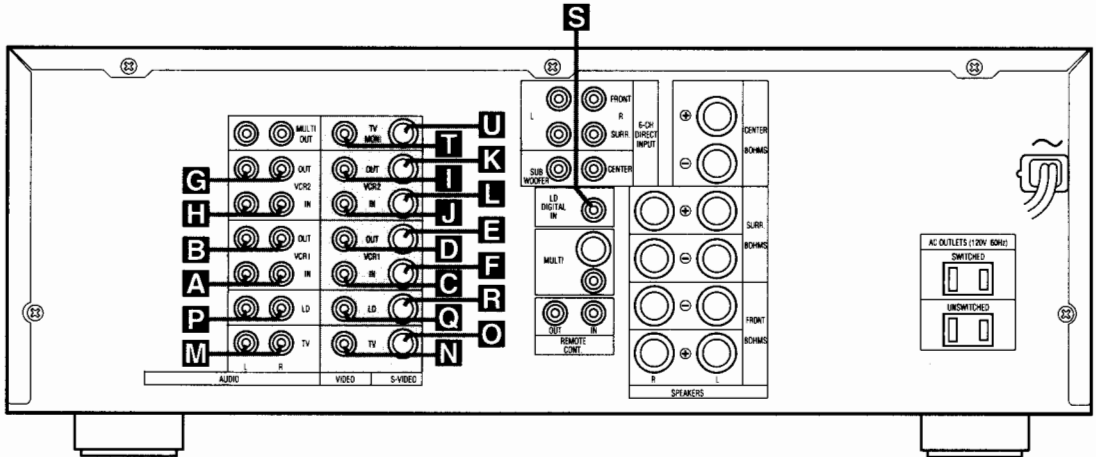

- A** VCR 1 Audio In
- B** VCR 1 Audio Out
- C** VCR 1 Video In
- D** VCR 1 Video Out
- E** VCR 1 S Video Out
- F** VCR 1 S Video In
- G** VCR 2 Audio Out

- H** VCR 2 Audio In
- I** VCR 2 Video Out
- J** VCR 2 Video In
- K** VCR 2 S Video Out
- L** VCR 2 S Video In
- M** TV Audio In
- N** TV Video In

- O** TV S Video In
- P** LD Audio In
- Q** LD Video In
- R** LD S Video In
- S** LD Digital In
- T** TV Monitor Video Out
- U** TV Monitor S Video Out

# Rear Panel Video Connections

11

**A VCR 1 Audio In:** Connect these jacks to the audio PLAY/OUT jacks of a VCR.

**B VCR 1 Audio Out:** Connect these jacks to the RECORD/IN audio jacks of a VCR.

**C VCR 1 Video In:** Connect these jacks to the composite video PLAY/OUT jacks of a VCR.

**D VCR 1 Video Out:** Connect these jacks to the composite video RECORD/IN jacks of a VCR.

**E VCR 1 S Video Out:** Connect these jacks to the "S" video RECORD/IN jacks of a VCR.

**F VCR 1 S Video In:** Connect these jacks to the "S" video RECORD/OUT jacks of a VCR.

**G VCR 2 Audio Out:** Connect these jacks to the audio jacks RECORD/IN of a second VCR.

**H VCR 2 Audio In:** Connect these jacks to the audio PLAY/OUT jacks of a second VCR.

**I VCR 2 Video Out:** Connect these jacks to the composite video RECORD/IN jacks of a second VCR.

**J VCR 2 Video In:** Connect these jacks to the composite video PLAY/OUT jacks of a second VCR.

**K VCR 2 S Video Out:** Connect these jacks to the "S" video RECORD/IN jacks of a second VCR.

**L VCR 2 S Video In:** Connect these jacks to the "S" video RECORD/OUT jacks of a second VCR.

**M TV Audio In:** Connect the audio outputs of a TV, cable converter or satellite receiver to these jacks.

**N TV Video In:** Connect the composite video output of a TV, cable converter or satellite receiver to this jack. The signals received at this jack are also used to trigger the "TV Auto-On" feature.

**O TV S Video In:** Connect the "S" video output of a TV, cable converter or satellite receiver to this jack.

**P LD Audio In:** Connect the audio output of a laser disc player to these jacks.

**Q LD Video In:** Connect the composite video output of a laser disc player to this jack.

**R LD S Video In:** Connect the "S" video output of a laser disc player to this jack.

**S LD Digital In:** Connect the coax digital output of a laser disc or CD player to this jack.

**NOTE:** This connection is for standard, two channel PCM audio. DO NOT connect the modulated RF digital output used for multichannel (AC-3) audio to this jack.

**T TV Monitor Video Out:** Connect this jack to the composite video input of a TV monitor or video projector to view the on screen control menus and output of the receiver's video switcher.

**U TV Monitor S Video Out:** Connect this jack to the S video input of a TV monitor or video projector to view S video sources selected by the receiver's video switcher.

# Remote Control Functions

12

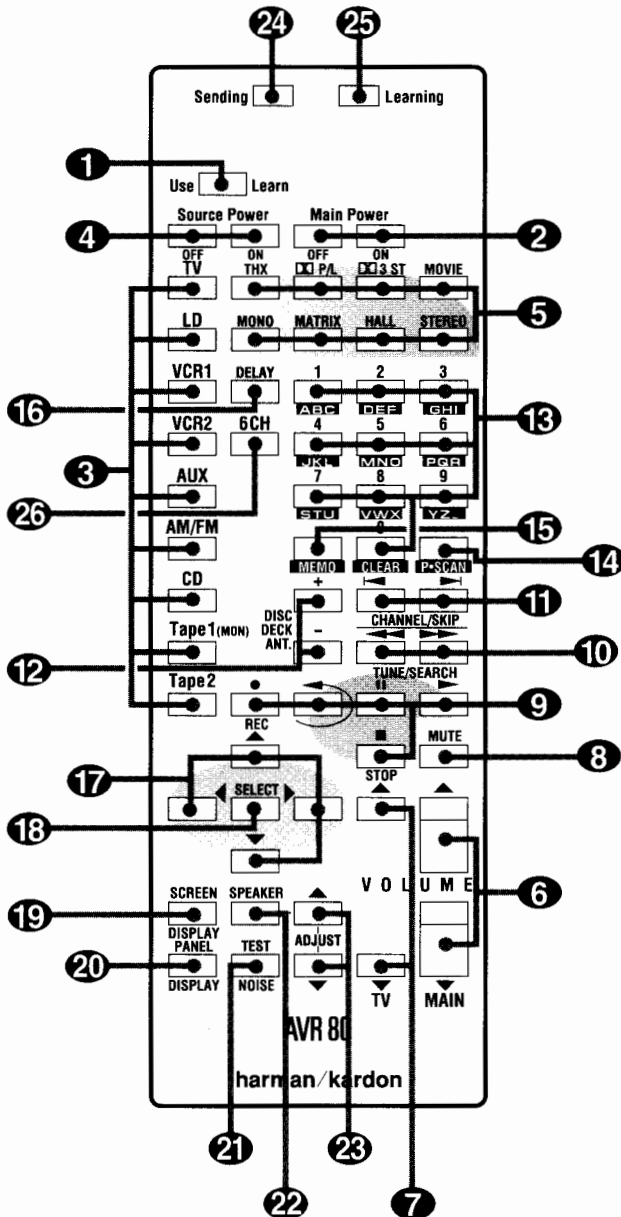

- 1 Use/Learn
- 2 Main Power
- 3 Source Selection
- 4 Source Power
- 5 Surround Mode Selection
- 6 Main Volume
- 7 TV Volume
- 8 Mute
- 9 Transport Controls
- 10 Tune/Search & Fast Forward
- 11 Channel/Skip
- 12 Disc/Deck/Ant
- 13 Number Keys
- 14 P-Scan
- 15 Memo
- 16 Delay
- 17 Menu Controls
- 18 Select
- 19 Screen Display
- 20 Panel Display
- 21 Test Noise
- 22 Speaker Select
- 23 Level Adjust
- 24 Sending LED
- 25 Learn LED
- 26 6Ch Direct

**1 Use/Learn:** This switch selects the operation mode of the remote control. Slide it to the left for normal operation. Slide it to the right when the remote is being programmed.

**2 Main Power:** Press these buttons to turn the unit on or off.

**3 Source Selection:** Pressing one of these buttons selects the input source that will be listened to through the receiver. When a source is selected the remote's transport and numeric number buttons will also transmit the commands needed to control that machine.

**4 Source Power:** Press these buttons to control power for the last source device selected.

**5 Surround Mode Selection:** Press one of these buttons to select a surround mode for the current listening session.

**6 Main Volume:** These buttons control the unit's volume. Note that all channels are controlled simultaneously.

**7 TV Volume:** These buttons adjust the volume for TV using the remote control codes programmed into the remote for a TV set or cable box. These buttons control the TV set only, regardless of which source is selected. This enables you to control the audio level of a TV set even when the receiver is not in use.



**8 Mute:** Press this button to temporarily cut the audio output of the receiver. Press it again to return to the previous volume level.

**9 Transport Controls:** These buttons control the tape or disc motion of the last playback source selected with the Source Selection buttons (3). Use them as you would the Play, Stop, Pause, Reverse Play and Record buttons on any VCR, CD or LD remote control.







**10 Tune/Search & Fast Forward:** (These buttons have multiple functions, which vary according to the input device selected.)

# Remote Control Functions



13

- a. When the **TUNER** has been selected, these buttons are used to manually tune stations.
- b. When **CD**, **LD** or **VCR** is the input source, these buttons act as the Fast Scan Forward  or Fast Scan Reverse  controls.

**11 Channel/Skip:** (These buttons have multiple functions, which vary according to the input device selected.)

- a. When the **TUNER** has been selected, these buttons will scroll up  or down  through the stations that have been programmed in the preset memory.
- b. When **TV** or **VCR** is selected, they are the channel up  or channel down  tuning buttons.
- c. When **CD** or **LD** is selected these buttons act as forward and reverse "Skip" buttons to move to the next track or chapter on the disc.
- d. When a compatible Harman Kardon cassette player has been selected as **Tape 1** or **Tape 2**, these buttons move the tape forward  or backwards  to the next selection using the Music Scan feature.

**12 Disc/Deck/Ant:** (These buttons have multiple functions, which vary according to the input device selected.)

- a. When **CD** is selected and the unit is a CD changer, these buttons will change to the next disc  or previous disc .
- b. When **Tape 1** or **Tape 2** is the input source, and the tape machine is a compatible Harman Kardon dual cassette deck, these buttons will switch between the "A" and "B" sides.
- c. When **VCR 1** or **VCR 2** is the input source, these buttons switch between VCR and TV as the unit's output.

- d. When **TV** is the input source, these buttons may switch between video input sources or antenna/video, depending on the TV model.
- e. When **LD** is the input source, these buttons will switch the side being played from "A" to "B" on compatible dual side players.

**13 Number Keys:** These buttons serve as a ten button numeric keypad to enter tuner preset positions. They are also to be used to select channel numbers when **TV** has been selected on the remote, or to select track numbers on a CD or LD player, depending on how the remote has been programmed. The letters below the buttons are used to enter information for tuner station names.

**NOTE:** The **0** button has a dual function. It also serves as the **CLEAR** button to for use in programming the tuner or clearing the system memory.

**14 P-Scan:** Press this button to automatically scan through the stations preset into the tuner memory. Press the button again to end the scan when the tuner stops at the desired station.

**15 Memo:** The memo button is used to enter stations to the tuner's preset memory in either the manual or automatic modes. It is also used in the process of clearing the memory.

**16 Delay:** This button controls the amount of sound delay to the rear (surround) channels. Press it to increase the delay in the steps shown in the main Information Display or on-screen graphics.

**17 Menu Controls:** These buttons control the action of the cursor or the selection of menu items when the receiver is being configured using the setup menus.

**18 Select:** This button enters settings to the receiver's memory during system configuration.

**19 Screen Display:** Press this button to activate the on screen menu system.

**20 Panel Display:** Press this button to turn off all displays and indicators in the Information Display except for a small **DISP** indication in the lower right corner of the display **12**. Press the button again to turn the display back on. Note that the display will briefly illuminate when a command is sent to the unit from the front panel or remote, even though the display is turned off.

**21 Test Noise:** Press this button to begin calibration of the output level for each channel. A test signal will immediately be heard from the left front speaker and the **TEST** indicator **2** will flash.

**22 Speaker Select:** When setting the system output levels, this button selects the speaker position being adjusted. Press it once to advance to the next speaker after each position is adjusted.

**23 Level Adjust:** When setting the system output levels, press these buttons in increase or decrease the output level.

**24 Sending LED:** This indicator should flash any time a button is pressed to confirm that a command is being sent to the receiver or another unit. If the light is dim or does not illuminate when a button is pressed the batteries in the remote should be replaced.

**25 Learn LED:** This indicator will illuminate when a button on the remote is being programmed with signals from another remote during the "learning" mode. The light will go out when the signal is received and memorized.

**26 6 Channel Direct:** When an external 5.1 digital audio decoder such as the ADP303 is connected, press this button to select that unit as an input source.

# Installation, Set Up & Configuration

14

## System Installation

After unpacking the unit, and placing it in on a solid surface capable of supporting its weight, you will need to make the connections to your audio and video equipment. These steps need to be done only when the receiver is first installed, or when a change is made to the input source equipment.

## Audio Input and Output Connections

Use the "Audio and Systems Connections" Diagram in the inside front cover as a guide to connecting audio components and speakers to the rear panel. We recommend that you use high quality cables when making connections to source equipment and recorders to preserve the quality of the signals.

**NOTE:** When making connections to audio source equipment or speakers it is always a good practice to unplug the unit from the AC wall plug. This prevents any possibility of accidentally sending audio or transient signals to the speakers that may damage them.

1. For playback only sources, such as a CD player, CD changer, external phono preamp or external digital to analog converter, connect the output jacks of the player to the appropriately labeled inputs on the rear panel. **Ⓒ**

**NOTE:** When the source device has both fixed and variable audio outputs it is best to use the fixed output unless you find that the input to the receiver is so low that the sound is noisy, or high that the signal is distorted.

2. When connecting recording devices such as cassette recorders, open reel tape decks, DCC, DAT or MD, connect the PLAY/OUT jacks of the recorder to the **IN** jacks **ⒹⒺ**. Connect the RECORD/IN jacks on the recorder to the **OUT** jacks **ⒸⒺ**.

3. Assemble the AM Loop Antenna supplied with the unit as shown below. Connect it to the **AM** and **GND** screw terminals **Ⓔ**.

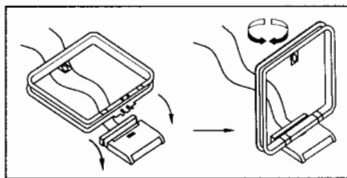

4. Connect an FM antenna to the **FM (75 ohm)** connection **Ⓐ**. The FM antenna may be an external roof antenna, an inside powered or wire lead antenna, or a connection from a cable TV system. Note that if the antenna or connection uses 300 ohm twin lead cable, you must use the 300 ohm to 75 ohm adapter supplied with the unit to make the connection.

5. Connect the front, center and surround speaker outputs **H I J K L** to the respective speakers.

To assure that all the audio signals are carried to your speakers without loss of clarity or resolution, we suggest that you use high quality speaker cable. Many brands of cable are available, and the choice of cable may be influenced by the distance between your speakers and this receiver, the type of speakers you use, personal preferences and other factors. Your dealer or installer is a valuable resource to consult in selecting the proper cable.

Regardless of the brand of cable selected, we recommend that you use a cable constructed of fine, multi-strand copper with a gauge of 14 or larger. Remember, that in specifying cable, the lower the number, the thicker the cable.

Cable with a gauge of 16 may be used for short runs of less than ten feet. We do not recommend that you use cables with an AWG equivalent of 18 or higher due to the power loss and degradation in performance that will occur.

One way to insure that cables will deliver a predictable level of performance is to use Home THX® certified cables. This certification assures that the cables have met a rigorous set of specifications designed for home theater applications.

Cables that are run inside walls should have the appropriate markings to indicate listing with UL, CSA or other appropriate testing agency standards. Questions about running cables inside walls should be referred to your installer or a licensed electrical contractor who is familiar with the NEC and/or the applicable local building codes in your area.



# Installation, Set Up & Configuration

When connecting wires to the speakers, be certain to observe proper polarity. Remember to connect the “negative” or “black” wire to the same terminal on the receiver and the speaker. Similarly, the “positive” or “Red” wire should be connected to the like terminal on the AVR80// and speaker.

**NOTE:** While most speaker manufacturers adhere to an industry convention of using black terminals for negative and red ones for positive, some manufacturers may vary from this configuration. To assure proper phase, and optimal performance, consult the identification plate on your speaker, or the speaker's manual to verify polarity. If you do not know the polarity of your speaker, ask your dealer for advice before proceeding, or consult the speaker's manufacturer.

6. Connections to a subwoofer are made via a line level audio connection from the receiver **M** to the line level input of a subwoofer with a built in amplifier. If a passive subwoofer is used, the connection first goes to a power amplifier, which will be connected to one or more subwoofer speakers.

7. If an outboard multichannel digital audio adapter is used, connect the six outputs of the adapter to the **6 CH. Direct Input** inputs **Ⓞ**.

## Video Input and Output Connections

Video connections are made in a similar fashion to those for audio components. Again, the use of high quality interconnect cables is recommended to preserve signal quality.

1. Connect the VCR's audio, video and “S” Video OUT jacks to the **VCR IN** jacks **A C F H J L** on the rear panel. The audio, video and “S” video IN jacks on the VCR should be connected to the **VCR OUT** jacks **B D E G I K** on the AVR80//.

2. Connect the audio, video and “S” video outputs of a satellite receiver, cable TV converter or television set to the **TV** jacks **M N O**.

3. Connect the audio, video and “S” video outputs of a Laser Disc player to the **LD** jacks **P Q R**. If your LD player has a coax digital output for 44.1kHz PCM audio, you will obtain higher sound quality by connecting that output to the **LD Digital In** jack **S**.

4. Connect the **TV MON T** jacks on the receiver to the video or “S” Video inputs of your television monitor or video projector.

## System and Power Connections

The AVR80// is designed for flexible use with external control components and power amplifiers. These connections are easy to make during an initial installation, or at a later date should you choose to upgrade your system.

### Remote Control Extension

If the receiver is placed behind a solid or smoked glass cabinet door, the obstruction may prevent the remote sensor from receiving commands. In this event, an optional remote sensor may be used. Connect the output of the remote sensor to the **Remote Cont. IN** jack **V**.

If other components are also prevented from receiving remote commands, only one sensor is needed. They may use this unit's sensor or a remote eye by running a connection from the **REMOTE CONT. OUT** jack **W** to the Remote In jack on Harman Kardon or other compatible equipment.

# Installation, Set Up & Configuration

16

## External Audio Power Amplifier Connections

Using the **PRE OUT** jacks **(N)**, connections may be made to external power amplifiers. To make these connections, remove the jumpers between **PRE-OUT** and **MAIN IN**, and save them for future use. Connect the **PRE-OUT** of the channels to be connected to external amplifiers to that amplifier's inputs. Volume will still be controlled by this receiver.

When an external amplifier is used for the front channels, this receiver's rear channel outputs and a passive (non-powered) subwoofer may be connected to this unit's internal amplifier for higher power output. To make these connections, follow the diagrams on this page. Using short RCA to RCA jumpers, connect the left and right **SURR PRE-OUT** jacks to the left and right **FRONT MAIN IN** jacks. A subwoofer may be connected by connecting the **SUBWOOFER PRE OUT** to the **CENTER MAIN IN**.

If these connections are used, changes must be made to the speaker outputs. Connect the left and right surround speakers to the speaker terminals labeled **FRONT (H I)** and the passive subwoofer to the speaker terminals labeled **CENTER (J)**.

**NOTE:** When external power amplifiers are used, the center channel speakers should receive at least as much amplifier power as the front left and right speakers.

## AC Power Connections

This unit is equipped with two accessory AC outlets. They may be used to power accessory devices, but they should not be used with high current draw equipment such as power amplifiers.

The **SWITCHED (T)** outlet will receive power only when the unit is on. This is recommended for devices that have no power switch, or a mechanical power switch that may be left in the "ON" position.

The **UNSWITCHED (U)** outlet will receive power as long as the unit is plugged into a powered AC outlet.

Finally, when all connections are complete, plug the power cord into a non-switched 120 volt AC wall outlet. Note that the ring surrounding the Power Switch **(S)** will turn amber. You're almost ready to enjoy the AVR80!!

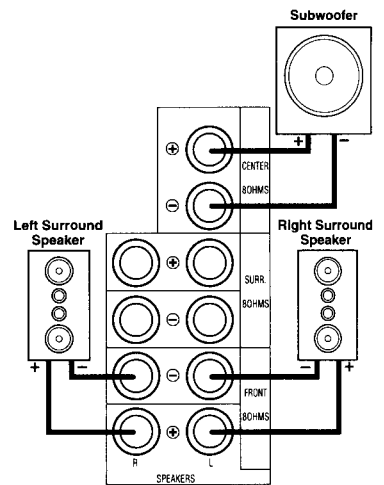
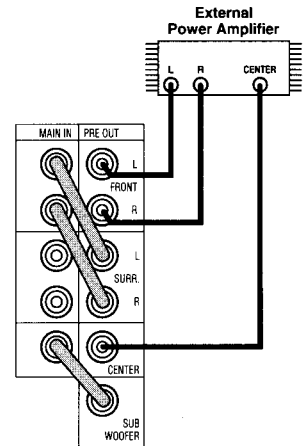

# Remote Control Programming & Operation

This product is equipped with a powerful remote control. As supplied, it will operate the receiver, as well as most CD players and tape decks manufactured by Harman Kardon. In addition, it is pre-programmed with the remote codes to operate VCRs, LD players and TV sets that are based on the popular RC-5 control code system. If your equipment requires different codes, it may be programmed to copy the codes from most infra red remotes.

## Loading Batteries

The life of the batteries for the remote control is about one year in normal operation. If the green **Sending** 24 indicator does not flash when remote buttons are pushed, that is an indication that the batteries need to be replaced. The batteries should be removed if the remote will not be used of an extended period of time.

## To change the batteries:

1. Remove the back cover by sliding it in the direction of the arrows.

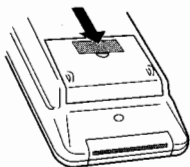

2. Remove the old batteries and insert fresh AAA type cells. Be certain to observe the correct polarity by noting the (+) and (-) marks on both the inside of the case and on the battery cells. It is recommended that both batteries be changed at the same time.

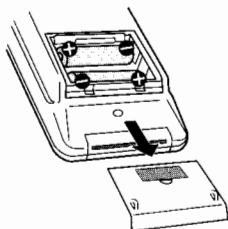

3. Close the cover until it clicks shut.

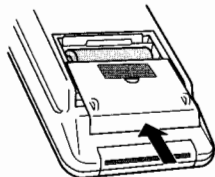

**NOTE:** It is important that the batteries be replaced within ten minutes after the old batteries are removed to avoid losing any remote codes that have been programmed into the remote's memory.

## Remote Control Range

The remote will operate at a range of up to 15 feet from the unit, when the batteries are fully charged. The remote will also operate at an angle of up to 30° to either side of the unit.

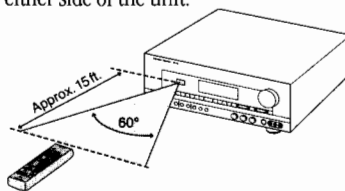

Always point the remote transmitter at the front of the unit when issuing commands. If you find that remote commands are not being received by the remote, it may be necessary to use a remote IR sensor.

## Remote Programming

### Programmable Keys

There are 63 buttons on the remote control that may be user programmed to new functions to operate virtually any component in your system. Ten CANNOT be programmed with a new code, as they control high level functions of the AVR80II. These keys are **Main Power ON**, **Main Power OFF**, and the eight source input keys: **TV**, **LD**, **VCR 1**, **VCR 2**, **TUNER**, **CD**, **TAPE 1** and **TAPE 2**.

Programmable keys are divided into two groups. Some keys may be programmed with a separate function for each of the inputs. Thus, these keys may change their code when the input source is changed. (i.e. The **Play** key may transmit a different code when **CD** is selected as opposed to when **VCR** is selected.) The keys that may be programmed with multiple codes are the following:

### All Numeric Keys (0 - 9)

- Forward Play ►
- Source Power On
- Reverse Play ◀
- Source Power Off
- Stop ■
- Disc/Deck +
- Record ●
- Disc/Deck -
- Pause ||
- Channel/Skip ►|
- TV Volume Up ▲
- Channel/Skip |◀
- TV Volume Down ▼
- Tune/Search ►►
- Memo
- Tune/Search ◀◀
- P-Scan

# Remote Control Programming & Operation

18

Another group of keys may only be programmed with one remote code. The code contained in these keys remains the same regardless of the source selection.

**WARNING:** These keys transmit codes that are vital to the operation of the product. It is not recommended that they be programmed with alternative codes, as it may then be impossible to operate certain functions of the receiver.

THX  
Aux  
Cursor Up ▲  
Pro Logic  
Delay  
Cursor Down ▼  
Dolby 3 Stereo  
Memo  
Cursor Right ►  
Movie  
Screen Display  
Cursor Left ◀  
Matrix  
Panel Display  
Select  
Hall  
Speaker  
Main Volume Up ▲  
Stereo  
Test Noise  
Main Volume Down ▼  
Mono  
Adjust  
Mute  
6Ch Direct

To program the remote, follow these steps. Note that it is not necessary to program all keys, only those that are required to operate the subject device. Keys not programmed will retain the codes preprogrammed at the factory.

1. Slide **Use/Learn** ❶ switch at the top left corner of the remote to the right so that it is next to **Learn**.
2. If one of the multi-function buttons is being programmed press the source button (i.e. **CD**, **VCR**, etc.) you wish to have this function associated with. If you are programming a single function key, proceed to the next step.
3. Press the button on the remote that is to be programmed. Note that the **Learning** ❷ LED will illuminate.
4. Place the remote head to head with the remote control whose function is being learned. The two remotes should be no more than 8 inches apart.
5. Press and hold the button on the remote corresponding to the function to be memorized until the **Learning** LED starts to blink. When the LED goes out, release the button on the transmitting remote. The function code has been successfully captured by the remote.

**NOTE:** If both LEDs flash during a programming operation, it indicates that the remote's memory is full or that the remote codes from the transmitting remote are not compatible with the unit's signal format.

6. Continue to program any additional remote commands required using steps 2 through 5. When you have finished programming the remote, slide the **Use/Learn** switch to the left so that it is in the **Use** position.

## Clearing the Remote Memory

In normal operation, codes for a new device may be programmed "over" the codes that have been previously programmed into the remote. It is also possible to clear the memory for individual keys, or for the entire remote. When a memory position is cleared, the remote will return to the original factory preset command.

To clear the memory for a specific individual key location, put the **Use/Learn** switch in the **Learn** position. Press the **Main Power Off** ❷ button and the button to be cleared at the same time. Both the **Sending** and **Learning** indicators will light momentarily. When the lights go out, the memory has been cleared of the user programmed code and returned to the factory preset. Return the **Use/Learn** ❶ switch to the **Use** position when you are finished.

To clear the remote's entire memory and return all keys to their factory preset commands first put the **Use/Learn** ❶ switch in the **Learn** position. Then press the **Main Power On** button ❷ and confirm that the **Learning** indicator ❷ has illuminated. While continuing to press the **Power On** button, press and hold the **Power Off** ❷ button until the **Learn** indicator goes off for about 3 seconds. It will then blink twice. Then release the two buttons. This indicates that the memory has been cleared of any user programmed commands and that the original commands have been restored. Slide the **Use/Learn** switch back to the **Use** ❶ position to return the remote to normal operation.

# System Configuration

19

When all audio, video and system connections have been made, there are a few configuration adjustments to be made. A few minutes spent to correctly configure and calibrate the unit will greatly add to your listening experience.

## Speaker Selection and Placement

The placement of speakers in a multi channel home theater system can have a noticeable impact on the quality of sound reproduced. For Home THX operation it is recommended that the speakers carry the certification mark of Lucasfilm Ltd.'s Home THX Division. However, with careful selection and placement, the AVR80// will deliver accurate reproduction with any high quality speakers.

No matter which type or brand of speakers are used, the same model or brand of speaker should be used for the front left, center and right speakers. This creates a seamless front soundstage, and eliminates the possibility of distracting sonic disturbances that occur when a sound moves across mis-matched front channel speakers.

For the most accurate and exciting reproduction of bass frequencies a separate subwoofer should be used. When THX Certified front channel speakers are used, a separate subwoofer is mandatory, as THX front and center speakers are not designed for extreme low frequencies.

The AVR80// may be used with either conventional (point source) surround speakers or with THX Certified diffuse surround speakers. No adjustment is needed to select the type of surround speaker used.

## Speaker Placement

Depending on the type of center channel speaker in use and your viewing device, place the center speaker directly above or below your TV or in the center behind a perforated front projection screen.

Once the center channel speaker is installed, position the left and right front speakers so that they are as far away from one another as the center channel speaker is from the preferred listening position. Ideally, the front channel speakers should be placed so that their tweeters are no more than 24" off center from the tweeter in the center channel speaker.

Depending on the specifics of your room acoustics and the type of speakers in use, you may find that imaging is improved by moving the front left and right speakers slightly forward of the center channel speaker. If possible, adjust all front loud-

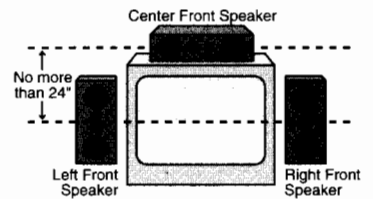

A) Front Channel Speaker Installation with Direct View TV Sets or Rear Screen Projectors

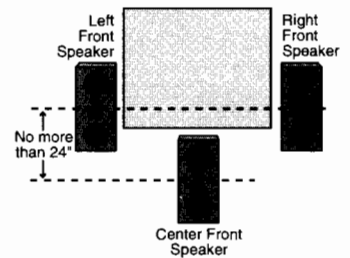

B) Front Channel Speaker Installation with Non-Perforated Front Projection Screen

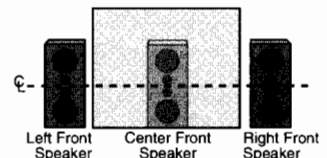

C) Front Channel Speaker Installation with Center Speaker behind a Perforated Front Projection Screen

# System Configuration

20

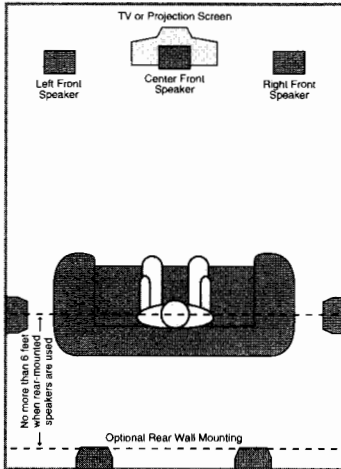

*The distance between the left and right speakers should be equal to the distance from the seating position to the viewing screen. You may also experiment with placing the left and right speaker slightly forward of the center speaker.*

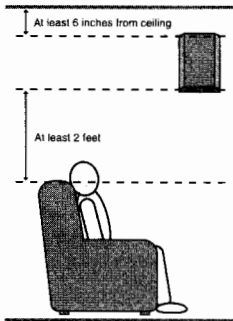

speakers so that they are aimed at ear height when you are seated in the listening position.

Using these guidelines, you find that it takes some experimentation to find the correct location for the front speakers in your particular installation. Don't be afraid to move things around until the system sounds correct. Optimize your speakers so that pans across the front of the room sound smooth, and that sounds from all speakers appear to arrive at the listening position at the same time without delay from the center speaker as opposed to the left and right speakers.

Note that some THX Certified center channel speakers must be placed vertically, while others may be placed horizontally. Consult the instruction manual accompanying your center speaker for the correct mounting position.

Surround speakers should be placed on the side walls of the room, at or slightly behind the listening position. The center of the speaker should face into the room with the active speaker drivers pointing towards the front and rear of the room. The speakers should be located so that the bottom of the cabinet is at least two feet higher than the listeners' ears when in the desired area.

If side wall mounting is not practical, the speakers may be placed on a rear wall, behind the listening position. Again, they should be located so that the bottom of the cabinet is at least two feet higher than the listeners' ears. The speakers should be no more than six feet behind the rear of the seating area.

Subwoofers produce non-directional sound, so they may be placed almost anywhere in a room. Subwoofer placement is highly influenced by room size

and shape, and the type of subwoofer used. Follow the instructions of the subwoofer's manufacturer, or experiment with the best location for a subwoofer in your listening room.

Once the speakers have been placed in the room and connected, the final step is to enter the configuration information and balance the speaker output levels. Before proceeding further this is a good time to review the installation section of the manual to make certain that all connections are properly made.

## System Settings

1. Plug the unit into an AC wall outlet and press the **Power** button on either the front panel **19** or the remote **2**. Note that the ring surrounding the front panel switch will turn green, and the front panel display will illuminate.

2. Turn on the TV connected to the receiver. Select the appropriate video input on the TV.

**NOTE:** Although the unit will switch "S" video signals, the on screen menu control system is NOT visible on the S video output.

3. Press the **SCREEN DISPLAY 19** button, and then press any of the navigational arrow buttons or the **SELECT 18** button on the remote to bring the **MAIN MENU** up on your video screen. (Figure #1)

4. Press the **▼** button five times until the on screen **>** cursor is pointing to **SET UP MENU**.

5. Press **SELECT 18** to move to the next screen, **SET UP MENU 1**. (Figure #2).

# System Configuration

21

6. The first item to be set is the Center Channel Mode. The on screen > cursor will already point toward this option when you select the menu. Press the ◀ or ▶ buttons **17** to choose one of these center channel options by moving the cursor:

**LARGE:** Choose this option if you are using either a THX Certified speaker system with a subwoofer or large size full range center channel speaker.

**SMALL:** Choose this option if the center speaker is small sized.

**NONE:** Choose this option if you are not using a center channel speaker.

7. When the center channel speaker selection is complete, press the ▼ button **17** to move to the next option. Note that the on screen > cursor will move down to **SUBWOOFER**.

8. Press the ◀ or ▶ buttons **17** to choose one of these options:

**ON:** Choose this option if a Subwoofer is installed. Selecting this option routes all low frequency information (below 80Hz) to the subwoofer output.

**OFF:** Choose this option if no Subwoofer is present.

9. Press ▼ **17** once and then **SELECT** **18** to move to **SET UP MENU 2** to continue the set-up procedure. (Press ▼ twice and then **SELECT** if you prefer to return to the **MAIN MENU**.)

10. At **SET UP MENU 2** (Figure #3) you are able to establish settings for multi-room operation and lock the control settings. You may skip these menus by pressing ▼ **17** until the on screen > cursor is next to **RETURN TO MAIN MENU** and pressing **SELECT** **18**.

11. If multiroom operation will be used, the first option enables you to select the method used for volume control. With the > cursor pointing to **MULTI RM VOL** press the ◀ or ▶ buttons to choose one of these options:

**VARIABLE:** Choose this option if the volume control in the remote rooms will be controlled by a remote control and a sensor connected to the **AVR80//** via the **MULTI IR** input on the rear panel.

**FIXED:** Choose this option if there is no remote control link to the remote rooms, or if you wish to have the volume in these rooms remain at a fixed, constant level.

12. When you have made your selection, press ▼ **17** to move to the next option, **SET LEVEL**. Press the ◀ or ▶ buttons **17** to set the volume in accordance with the option chosen in the previous menu:

a. If you selected **VARIABLE** Volume Set, this option selects the volume level at the remote rooms when the system is first turned on in those locations.

b. If you selected **FIXED** Volume Set, this is the level that will remain constant in the remote rooms.

13. When you have made a volume selection, press ▼ **17** to move to the next option. Note that the > cursor should point to **SET UP LOCK**.

14. This option enables you to lock the settings at the **SET UP MENU 1**. This makes it difficult for someone to inadvertently change the settings by causing the word **LOCK** to appear at the top of **SET UP MENU 1**. Before any further

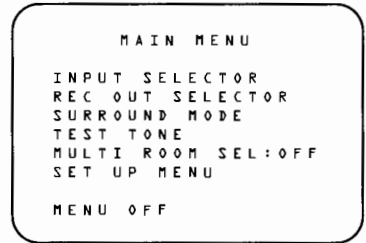

Figure 1

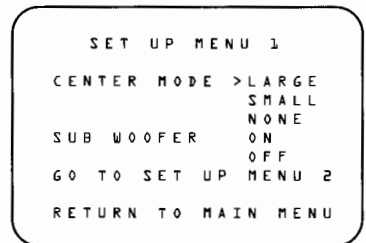

Figure 2

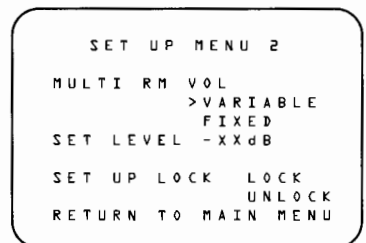

Figure 3

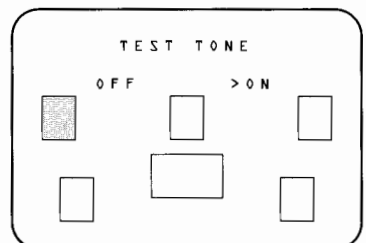

Figure 4

# System Configuration

22

changes are made, the user must first go to **SET UP MENU 2** and unlock the system. Press the ◀ or ▶ buttons **17** to choose one of these options:

**LOCK:** Choose this option to lock the settings as described above.

**UNLOCK:** Choose this option to unlock the settings and enable them to be changed without going to this menu.

15. When you have made your choice, press ▼ **17** and then **SELECT 18** to return to the main menu. At this point the output levels for all channels will be set to a reference so that the sound level is the same from each speaker. This compensates for the differences between the speakers used and the distance each speaker is from your listening position.

At this point you may wish to adjust the rear channel delay time. See the Advanced Features section later in this manual for information on delay settings.

**NOTE:** Before setting the output levels it is critical that the front panel bass **27** and treble controls **28** be set to their center, or “12 o’clock” position. This ensures accurate results.

16. At the **MAIN MENU**, press ▼ three (3) times until the > cursor is next to **TEST TONE**. Press **SELECT** to continue.

17. When you press **SELECT** you will immediately hear a test noise from the front right speaker. The on screen display will change to a graphic representation of each of the speakers in your room, with one speaker position blinking. (Figure #4) That speaker is the one whose level is being set.

**NOTE:** This procedure will only operate if the AVR80// is in the **THX, PRO LOGIC, MOVIE** or **DOLBY 3 STEREO** Modes. If the test tone cannot be selected, check to see which surround mode is indicated in the front panel display. If it is not one of the four modes mentioned above, press the ◀ button to cancel the test procedure. Select one of the correct modes, and then move the cursor to test tone to re-start the procedure.

18. While seated in the primary listening position, you should hear a test noise signal from the left front speaker. You may leave the volume setting where it is, or raise it to an appropriate level using the **ADJUST ▲** or **ADJUST ▼ 23** buttons on the remote. For a more precise calibration, we recommend that you use a sound pressure level meter, as described at the end of this section.

19. Press **SPEAKER 22** on the remote. Note that the sound should now come from the Center Channel speaker, and the icon for that speaker will flash on the screen. Use the **ADJUST ▲** and **ADJUST ▼** buttons **23** on the remote to change the level of the test noise so that it appears to be equal in level to the Front Left speaker.

20. Press the **SPEAKER** button again, and repeat the procedure for the Front Right, Surround Right, Surround Left and Subwoofer channels. Each time, use the **ADJUST ▲** and **ADJUST ▼** buttons **23** on the remote to change the volume level so that all speakers match, and then press **SPEAKER 22** to move to the next channel.

**NOTE:** This test also serves as an opportunity to verify that all speakers are properly connected. If the sound from a

speaker location does not match the location shown on the video and front panel displays, turn the AVR80// off and check the speaker wiring to make certain that the speaker is connected to the correct output terminals.

21. When all speakers appear to have an equal volume, press the ◀ button **17** on the remote to complete the procedure.

For a more accurate calibration of the speaker output levels perform the test outlined in steps 18 through 21 using a sound pressure level (SPL) meter. For calibration to THX standards, it is recommended that the output for each channel measure 75 dB (C-weighted, slow) on the meter. An inexpensive SPL meter may be purchased from Radio Shack stores as the model 32-2050 or 32-2055.

**NOTE:** You may also check the output levels at any time by pressing the **TEST NOISE** button **21**. When the on screen display is also activated by pressing **SCREEN DISPLAY 19**, you will see the speaker icons and level information superimposed on your video screen. Follow the instructions in steps 18 through 20 above to calibrate the system, and press the **TEST NOISE** button **21** again to cancel the test.

**CONGRATULATIONS!** You have completed a basic set up and you are now ready to enjoy the finest in home theater and music listening enjoyment.



# Basic Operation

23

Once the input, speaker and antenna connections have been made, and the system has been configured, the receiver is ready for operation. Note that some controls are duplicated on both the front panel and the remote control, while others appear on one or the other, but not both.

To turn the AVR80// on for the first time, press the front panel **POWER** button **19**.

Note that the front panel will light up and the unit will return to the last input source selected and the front panel displays will illuminate. If the unit is connected to a TV set the current operating conditions will appear briefly on screen.

Once the unit has been turned on with the front panel switch it may then be turned on and off for future use using the **Main Power** **2** buttons on the remote. Note that the remote power will NOT operate unless the **Power** button has first been manually depressed.

## Source Selection

To select or change the input source, press one of the **Source** buttons on the front panel **3 4 5 6 7 8** or one of the Source buttons on the remote **5**.

**NOTE:** Once you have programmed your remote control with the proper infrared commands for your TV set, a "Power On" command will automatically be sent to the TV when you select the TV input using the remote control.

To listen to one source while you watch another, first select the video source (**LD**, **TV**, **VCR1**, **VCR2** or **Aux**), and then select the desired audio source (**AM/FM CD**, **Tape 1**, **Tape 2**).

**NOTE:** When the unit is in "standby" mode, pressing any of the source buttons will turn on the unit.

The audio source will be displayed on the Information Display, while the video source will be displayed in the upper left corner of the Fluorescent Display next to the word **VISUAL** **1**.

## Volume Control

The AVR80//'s volume is controlled using either the front panel knob **18** or the **MAIN VOLUME** buttons **6** on the remote.

**NOTE:** Unlike conventional mechanically driven volume controls, this receiver's volume is set using digital devices. This means that the volume knob has no firm stopping point at either end of its rotation. Depending on the speed with which the knob is turned, it is normal for as many as three complete rotations to be required for full travel from the loudest setting to the softest.

When the volume is adjusted, the word **Master** will appear in the main portion of the Information Display, followed by a two digit number. The number indicates the variation from the reference point established when the output levels are set.

## Surround Mode Selection

One of the most important features of the AVR80// is its ability to reproduce a full multichannel surround soundfield from both surround encoded programs, and standard stereo programs. In addition, this is one of the few receivers available that is equipped for Home THX, the ultimate in home theater. In all a total of eight listening modes are available on the AVR80//.

Selection of a surround mode is based on personal taste, as well as the type of program source material being used. For example, motion pictures bearing the logo of one of the major surround encoding processes, such as Dolby Surround, DTS Stereo or UltraStereo may be played in either the THX Cinema, Dolby Pro Logic or Movie Surround Modes. TV or radio broadcasts of programs in surround, but not originally produced as theatrical motion pictures should be played back in the Dolby Pro Logic or Movie Surround modes. Other mode selections are described elsewhere in this manual.

**NOTE:** Once a program has been encoded with surround information, it retains the surround matrix as long as the program is broadcast in stereo. Thus, movies with surround sound will carry surround information when they are broadcast via conventional TV stations, cable, pay TV and satellite transmission. In addition, a growing number of made for television programs, sports broadcasts, radio dramas and music CDs are also recorded in surround sound. You may obtain a list of these programs and discs from Dolby Laboratories Licensing Corp., 100 Potrero Avenue, San Francisco, CA 94103.

Surround modes may be selected in one of three ways.

From the front panel, use the **Mode▲** or **Mode▼** buttons **13** to scroll through the list of modes. The selected mode will appear in large letters in the front panel display, and in a two line reminder on the video screen. Once the selection is made, the mode will continue to appear in a smaller indicator at the bottom of the front panel display.

# Basic Operation

24

**IMPORTANT NOTE:** Many people incorrectly presume that sound should always be heard from the surround channels. In reality, it is normal for the surround channels to operate occasionally, and often to be silent. Movie directors and sound mixers typically use these channels only when needed to create an effect or establish ambience. Artificially increasing the volume level to the surround channels may destroy the illusion of carefully controlled audio effects and add unwanted noise to your system.

From the remote, modes may be selected by simply pressing the button that corresponds to the desired mode. **5**

Modes may also be selected using the on screen display. Press **SELECT** **18** on the remote to display the **MAIN MENU**. Then press **▼** **17** twice so that the on screen cursor is next to **SURROUND MODE**. Press **SELECT** **18** again to move to the next menu.

At the **SURROUND MODE MENU**, press the **◀** or **▶** buttons **18** until the desired mode name appears on the screen. Press **▼** twice until the **>** cursor is next to **RETURN TO MAIN MENU** and press **SELECT**. At the main menu select **MENU OFF** and press **SELECT** to exit the menus.

A different mode may be selected for audio and video sources. Once a mode has been selected, it will be attached to those sources in memory. Thus, you may select **THX CINEMA** as the mode for video and **HALL SURROUND** for audio. After the initial selections made, the unit will automatically return to your preferred mode for each type of input whenever it is chosen.

## TV Auto Function

With the increasing sophistication of today's home entertainment systems, it often takes numerous remote controls to turn on all components in a system. This receiver's unique "TV Auto On" function greatly simplifies that task and reduces the actions needed to bring your entire system to life.

If you are using a TV or projector that has video output, and you wish to use the output of its tuner as an audio source for the AVR80//, connect the TV's audio and video outputs to the rear panel of the AVR80//. **MN** Once those connections are made, the AVR80// will automatically turn on whenever the TV set is on, thanks to a video sensing circuit in the AVR80//. This eliminates the need to turn the unit on separately from the TV.

As long as the TV is on and feeding a video signal, the AVR80// will remain on. If no other input source is selected and the TV is turned off, the AVR80// will turn off approximately five minutes after the TV set.

If you select another input, such as CD or the AM/FM tuner after the unit has turned on, it will remain on even if the TV is turned off. You must then turn the receiver off using the front panel or remote **POWER** buttons. **2 19**

**NOTE:** The TV Auto On Function will only respond to conventional video signals. It will NOT operate with S-Video.

**IMPORTANT NOTE:** If you do not have a video source connected to the **TV VIDEO N** input, or do not wish to use this feature, it is important that you disable it. To disable the TV Auto on feature press the **TV** and Memo **7 24** buttons on the front panel at the same time. Hold

them for a few seconds until the front panel information display shows **TV AT ON**. Immediately release both buttons and then quickly press the **TV** button **7** again. The front panel display will read **TV AT OFF**. Release the button to complete the system change. Should you wish to reactivate the feature again in the future, press the buttons as shown above and then press the **TV** button until the display again reads **TV AT ON**.

## Tuner Operation

The FM/AM tuner is extremely flexible, and offers a number of options. The following instructions will enable you to take advantage of the tuner's many features.

To select tuner operation, press the **AM/FM** button **3** on the front panel, or the remote **3**. Press the button again to select the desired frequency band if required.

Manual up/down tuning is accessible by pressing the **TUNE** button **16** either up **▲** or down **▼** or the Tune/Search **◀◀** and Tune/Search **▶▶** **10** buttons on the remote. Pressing these buttons once increases or decreases the station frequency by one step. Holding the buttons down quickly scans for the next station. Holding the tune buttons for a few seconds and then releasing them will set the tuner to the next station with an acceptable signal.

When manually tuning stations, observe the **SIGNAL LEVEL** indicator **16** and the **TUNED** **5** indicators. The more bars visible on the **SIGNAL LEVEL** indicator, the stronger the signal and the better the station will sound. A station is properly tuned when the **TUNED** indicator is illuminated.

# Basic Operation

25

## Tuner Mode

Pressing the **FM Mode** button **26** on the front panel selects how a station will be received. When the button is pressed so that the **AUTO** **4** indicator is lit, stations broadcasting in stereo will be received in stereo. You may note stereo broadcasts by observing that the **STEREO** **6** indicator will illuminate. When the **FM Mode** button **26** is pressed until the **AUTO** **4** light goes out, all stations will be received in a monaural mode regardless of the method of transmission.

**NOTE:** When a station is broadcasting in stereo, but has a weak signal level, the reproduction may not be acceptable. In this case, select the Auto Off mode, as monaural reception is less susceptible to noise in weak reception areas.

## Tuner Presets

There are thirty preset positions may be used to store your favorite stations in any order. These may be used to memorize both the station's frequency, reception mode and a name. Stations may be preset automatically or manually, and then recalled in a variety of ways.

### Automatic Station Preset Selection

This process automatically scans the AM and FM bands and enters all stations with proper signal strength into the memory. To automatically preset the tuner's memory, follow these steps:

1. Select the tuner as the unit's input by pressing the **AM/FM** button **3** **3**.
2. Using the **TUNE** **16** **10** buttons, select the first station you wish to preset at the low end of the AM or FM band.
3. Start the automatic tuning preset by simultaneously pressing **MEMO** and

**TUNE** **▲** on the front panel **24** **16** or remote **15** **10**. The station tuned in step #2 will be entered into the tuner's memory as **CH 1**. The **MEMO** **3** and **AUTO MEMO** **15** indicators will flash. The display will show increasing frequencies to indicate that the auto scan is in progress.

4. Each time the tuner finds a station the scanning will pause and the station will be played for five seconds. During this time you have the following options:

a. To enter the station in the next open memory position, no action is needed. After five seconds the tuner will enter the station and the preset number will be visible at the far left side of the main information display.

b. The frequency band may be changed by pressing the **FM/AM** button **3** **3**.

c. If the tuner is scanning FM stations, the **MODE** may be changed from **AUTO** to mono by pressing the **FM MODE** button **26**.

d. If you do not wish to enter the current station into the preset memory, press the **TUNE** **▲** button **16** **10** on the front panel or remote.

5. After the desired action is completed, or five seconds elapse, the tuner scan will continue. The operation will stop automatically when all 30 preset positions are filled or when both frequency bands have been completely tuned, whichever comes first. To stop the automatic preset process at any time press the **CLEAR** button **25** or any input selection button.

### Manual Tuner Preset

Stations may be manually entered into the tuner's memory in any order. Manual

entry is performed from the remote control only.

1. Tune to the desired station as outlined in Tuner Operation Section.

2. Press the **MEMO** button **24** **15** and note that the **MEMO** indicator **3** will flash.

3. While the indicator is flashing for the next 5 seconds, enter a number from 1 to 30 using the number buttons on the remote **13**. Any number may be used, but if another station has already been programmed into the location number selected, the previous setting will be lost.

a. To enter a single digit memory location, press **0** before the number, or enter the number and wait a few seconds.

b. If an invalid number (other than 1–30) is entered in error, the display will flash to alert you that the entry is invalid and it will return to the previous frequency display.

4. When the preset memory has been properly programmed the **MEMO** indicator **3** will stop blinking.

### Station Name Preset

In addition to identifying stations by their broadcast frequency, each preset station may be assigned a name using alphanumeric characters. This enables you to identify a station by its call letters, program format, or any other five character phrase.

To enter a station name, first preset all stations you wish to program into the tuner's memory. Then, follow these steps:

1. Tune to the desired preset station.

# Basic Operation

26

2. Press the **MEMO** button **24** on the front panel for more than three seconds.

3. Note that a character on the left side of the main information display will start to blink.

4. Enter the first character of the name using either the front panel **TUNE ▲** or **▼** buttons **16** or the alphanumeric buttons **13** on the remote.

A. To use the front panel buttons simply press and hold **TUNE ▲ 16** button until the desired letter or number appears. Note that the upper case alphabet will appear, followed by the numbers **1** through **0**, and then a **\_** indicating a blank space. Tapping the button will advance the display one character at a time; holding it down will move the display quickly. If you pass by the desired character, use the **TUNE ▼ 16** to move the display in reverse.

After entering the first character, press **MEMO 24** to move to the next position and note that the next digit will blink. Use the same procedure outline above to enter a character.

When you have entered a digit or “blank” in all five spaces, press **MEMO 24** to confirm the entry

B. To use the remote for character entry, press the button corresponding to the desired letter or number. Press it once to enter the first printed letter, twice for the second, three times for the third and four times for the number. Press the “**9**” button to enter a blank space. (For example, press the “**ABC**” button once to enter an “**A**”, three times for a “**C**” and four times to enter a “**1**”.)

Use the **MEMO** button **15** to move to the next digit position. When all five spaces have been filled, press **MEMO** again to confirm the entry.

Once a station name has been attached to a preset position, the station’s frequency will appear briefly when the unit is tuned to that station. After a few seconds the preset name will appear in the display.

## Tuning Preset Stations

Stations preset into the tuner’s memory may be recalled in a number of ways.

1. To recall a station directly enter a number from 1 to 30 using the number buttons on the remote **13**.

a. To enter a single digit memory location, press **0** before the number, or enter the number and wait a few seconds.

b. If an invalid number (other than 1–30) is entered in error, that number will flash to alert you that the entry is invalid and the display will return to the previous frequency display.

2. To scan through the list of preset stations, press the **P-SET ▲** or **P-SET ▼** button on the front panel **14**. Press once to move up or down through the memory presets one by one, or press and hold the button to quickly scan through the list of stations.

3. To automatically review each station in the memory, press the **P-SCAN** button **14 15**. Note that the **P-SCAN** indicator **14** will blink.

4. The tuner will move up through the list of stations, pausing to play each for five seconds. Note that preset numbers

where no station has been programmed will be skipped.

5. When the desired station is reached press **P-SCAN 15** or **CLEAR 25**.

## Clearing Preset Stations

Once stations are programmed into the preset memories, it is possible to remove them individually or as a group.

To remove a single station from the memory:

1. Recall the station by pressing the buttons on the remote corresponding to the station’s memory location.

2. Press the **MEMO** button **24** or **15** and observe that the **MEMO** indicator **3** will blink.

3. While the indicator is blinking, press the **CLEAR** button **25** within five seconds. The word **CLEAR** will show briefly to confirm that the memory position has been cleared.

To clear *all* memory locations, the volume level and surround mode memories:

1. Press the **MEMO** button **24 15** and the **CLEAR** button **25 13** at the same time.

**NOTE:** When a complete memory clear is performed the AVR80// will turn off as part of the process. After clearing the memory it is necessary to reset all stations and set up parameters.



# On Screen Display

28

## Input Selection

When the source input is changed, this message will appear (Figure #7). The top line is the audio input source, the bottom line is the video input source. Remember, when choosing an input, select the video source first, and then the audio source if a split input/simulcast listening session is desired. Note that when the **TAPE COPY** function is engaged, the **AUDIO** source is displayed in reverse video.

## Tape Copy Input Selection

When an input is selected for either **TAPE1** or **VCR1** copy, the choices appear as a message with the TAPE1 information on the top line and the VCR1 information on the bottom line. (Figure #8)

## Surround Output Levels

To obtain a status screen with the outputs for each individual channel, press the **SPEAKER** button **22** on the remote. A summary will appear for ten seconds. (Figure #9)

## Master Volume

When the volume is changed, a horizontal scale will briefly appear at the bottom of the screen with the volume level. (Figure #10)

## Mute

When the unit is placed in audio mute, the word **MUTE** will appear in the upper right corner of the screen as a reminder that the volume has been cut. (Figure #11)

## On Screen Display Function

If you do not wish to have the on screen displays appear, press and hold the **SCREEN DISPLAY** button **19** on the remote for three seconds. A reminder message will appear on the screen for a few seconds (Figure #12), and the displays will then be canceled until they are once again activated.

**NOTE:** Additional display messages appear as a part of the Multiroom system. These are described in the portion of this manual dealing with that topic.

## Using The On Screen Menus for System Control

Besides conveying status messages, the on screen display system may also be used as a means of controlling the operation of the unit. To operate the control system, always start by pressing **SELECT 18** on the remote to bring up the Main Menu. (Figure #1). Then, use the up/down navigational arrow keys **▲** and **▼ 17** to move the cursor. Press **SELECT 18** to choose a menu, and then use the left/right navigational arrow keys **◀** and **▶ 17** to view the choices in that current option. Finally, when the desired choice appears, press **SELECT 18** to enter the choice and return to the **MAIN MENU**. To exit from the Menu Control System, press **▼ 17** until the on screen **>** cursor is pointing to **MENU OFF** and press **SELECT 18**.

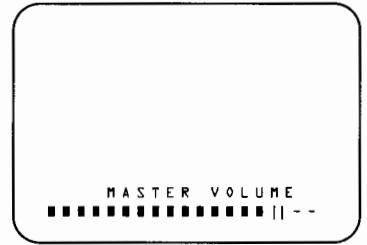

Figure 10

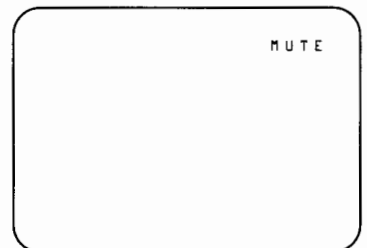

Figure 11

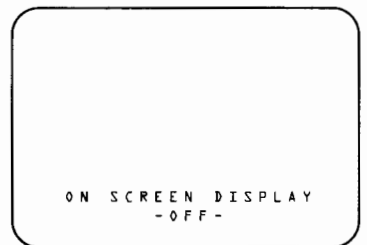

Figure 12

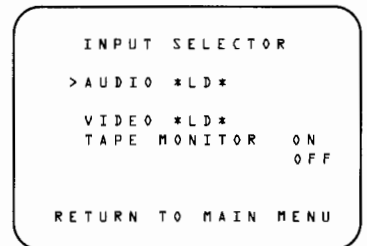

Figure 13

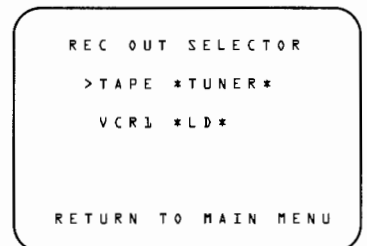

Figure 14

# On Screen Display

29

The following functions of the AVR80II may be controlled through the Menu Control System:

**INPUT SELECTION:** After reaching the **INPUT SELECTOR** menu (Figure #13), use the arrow keys on the remote **17** to select the desired input. Remember that when a split listening session is desired, select the **VIDEO** source first, followed by the **AUDIO** source. To use the Tape Monitor, press the down arrow button **17** to move the on-screen cursor. Use the **◀** and **▶** arrow buttons to turn the Tape Monitor On or Off.

**RECORD OUT SELECTION:** After reaching the **REC OUT SELECTOR** menu (Figure #14) use the navigational arrow keys to select the input to either **TAPE 1** or **VCR 1**. Note that if the current main input **SOURCE** is chosen, two more lines will appear on the screen to remind you which audio and video sources are selected. (Figure #15).

**SURROUND MODE:** After reaching the **SURROUND MODE** menu (Figure #16), use the navigational arrows **17** to select the desired mode. When a mode is selected that uses the surround channels, you may change the rear channel **DELAY TIME** at this menu.

**TEST TONE:** At this menu you may adjust the speaker output levels. For information on this procedure, refer to the System Configuration section of this Manual.

**MULTI-ROOM SEL:** For information on configuring and using the multiroom audio functions of the AVR80II, consult the appropriate section of this Manual.

**SET UP MENU:** For information on using the Set Up menus, refer to the System Configuration section of this Manual.



Figure 15

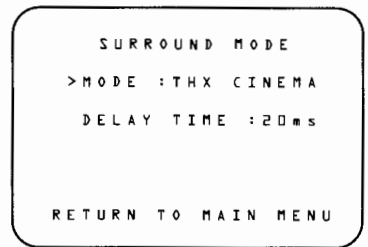

Figure 16

# Advanced Features

30

In addition to basic audio functions, this receiver is capable of both sophisticated audio/video dubbing and a wide range of surround modes. Advanced digital signal processing provides specialized surround modes that are compatible with virtually all types of music software and movie soundtracks.

For the ultimate in sound reproduction, the AVR8077 is equipped for digital input from laser disc or CD players with a coaxial digital output, so that the sound reaching the surround processor comes directly from the disc.

Finally, the AVR8077 is prepared for the future with provisions for connection to outboard multi channel (Dolby Digital and DTS) digital audio decoders.

## Audio Tape Dubbing

The input to the audio recorders is normally the source currently selected for listening through the AVR8077. If you are using a tape recorder or cassette deck with three heads and wish to listen to the "off tape" playback to verify the recording, press the front panel **T-MON** **5** button or the **TAPE 1 (MON)** **3** button on the remote until the red light over **T-MON** on the front panel illuminates. You will then hear the source as it is being recorded and played back through your tape machine. The source will be verified in both the front panel and on screen displays. Note that the video surrounding the word **AUDIO** will turn white to indicate that you are in the Tape Monitor mode.

To record one input source while you listen to another select the desired output by pressing the front panel **Record Out Tape-1** copy button **22**. Each press of the button will change the output to the tape recorder in the following order:

**SOURCE** → **TUNER** → **CD** →  
**TAPE 2** → **SOURCE**

Once the input is selected you may change the input for the main listening system without fear of disturbing the recording as long as the AVR8077's power is on.

**NOTE:** It is not possible to select one of the video inputs (**VCR1**, **VCR2**, **LD**, **AUX**) as a direct recording source using the **Record Out** select button. To make an audio recording from one of these sources first select the desired source as the main input, and then use the **Record Out TAPE 1** button **22** to select **SOURCE**.

## Video Dubbing

Video dubbing is similar to that for audio recording, with changes to accommodate the requirements of recording both an audio and video source. For video recording it is important to note that the output to **VCR1** only is selected with the front panel switch. The output to **VCR2** is always set to the current input source. (Unless that Source is **VCR2**, in which case the **VCR2** record output is blank.)

To select inputs for VCR dubbing use the **VCR1 COPY** button **23** on the front panel.

At the first press of the button, a status display will appear on both the front panel display and the on screen video menus (Figure #8) to remind you that the input source currently in use is also being routed to the **VCR1** output. If this is acceptable, no further action is required.

To record a source other than the input, press the **VCR1 COPY** button again, and note that the display will change in the following order:

**SOURCE** → **TV** → **LD** →  
**VCR 2** → **AUX** → **SOURCE**

Press the button until the input you wish to record appears. You may now change

the main listening input without fear of disturbing the recording as long as the unit's power remains on.

**NOTE:** Input sources for either the audio or video tape outputs may also be selected using the on screen video menu system described elsewhere in this manual.

## Audio/Video Simulcast Recording

It is possible to record the video from one source along with the audio from a different input. This is useful in the case of musical programs where the sound is being broadcast via FM, or for sports events where you wish to have the picture from a TV station, but the play-by-play from a radio station.

To create a simulcast recording first select the video source input (**TV**, **LD**, **VCR2**, **AUX**) using the input selection buttons on the remote control or front panel. **7 8 3** Next, select the audio source (**FM/AM**, **CD** or **TAPE**) **3 4 5 6**. Note that the on screen on screen menu display will show the split sources (Figure # 7). The front panel display will show the audio source in large letters in the main portion of the Information Display, while the video source will appear in smaller letters next to the **VISUAL 1** indicator. Once the split source is configured, select **SOURCE** as the input for VCR1 by pressing the **VCR1 COPY** button.

Input sources for **VCR1 COPY** dubbing may also be made using the on screen video menu system.

## Delay Time Adjust

One aspect of the surround modes is the delay of audio signals between the front speakers and the rear speakers. Each surround mode is factory preset with a specific delay time, but it is possible to individually adjust the delay timing to custom tailor the sound to your individ-



ual taste and the acoustic conditions in your listening room or home theater.

The factory setting is appropriate for most rooms, but some installations create an uncommon distance between the front and surround speakers that may cause the arrival of front channel sounds to become disconnected from surround channel sounds.

To re-synchronize the front and surround channels, follow these steps:

1. Measure the distance from the listening/viewing position to the front speakers.
2. Measure the distance from the listening/viewing position to the surround speakers.
3. Subtract the distance to the surround speakers from the distance to the front speakers and add 15. The resulting number is the ideal delay time for your room. For example, if the front speakers are 10 feet away and the surround speakers are 5 feet away, the formula will be "10-5+15=20". Thus, the correct delay time in this room would be 20ms.

**NOTE:** The delay time may only be adjusted in certain modes.

If the delay time needs to be changed, it may be increased by pressing the **DELAY** button **12** **16** on the front panel. The delay time will be briefly displayed on the video menus as well as the front panel.

In addition to the use of the delay time formula, it is a good idea to understand the features of each of the AVR80//s surround modes when entering delay time. The chart on the next page provides an explanation of the suggested for each mode. The chart also contains the delay time limits for each of the modes.

## Direct Digital Decoding

The AVR80//s digital signal processing uses sophisticated microprocessors and advanced digital audio engines that manipulate sound in the digital domain. In order to work with sound, these circuits must first convert the incoming analog audio input to a digital signal. After processing, the digital audio signal must be converted back to analog for volume control and amplification.

While the digital to analog (D/A) and analog to digital (A/D) circuits in the AVR80// are high quality, any time an audio signal is digitized or reconstructed to analog there is the possibility of quality loss. This helps you to avoid un-needed A/D and D/A conversion from any laser disc player equipped with a coaxial digital output.

If your player has this type of output, connect the LD player to the AVR80// with a high quality digital or coax interconnect. The connection should be made to the **LD DIGITAL IN** jack **S** on the rear panel.

Once this connection is made, the AVR80// will accept the digital output directly from your LD player. To select the direct digital input, press the LD button **7** **4** and hold it for three seconds. This means that audio signals will remain in their pure digital state until after all surround processing has taken place.

**NOTE:** This connection is for standard two channel 44.1 kHz PCM digital audio, as provided by LD or CD machines. It is NOT an input for multichannel digital audio signals such AC-3 or DTS. Improper connection to the wrong type of digital output may cause damage to the AVR80// or other components in your audio system and are not covered by the AVR80// warranty. Consult your dealer or installer if you have any questions about this input.

## 6 Channel Direct Operation

Since 1993, an increasing number of theatrical motion pictures have been recorded with digital sound tracks. With these new processes such as Dolby Surround Digital™, DTS® and Sony's SDDS®, five or more discrete sound channels are available along with a dedicated subwoofer channel for low frequency sounds. The replacement of analog matrix theatrical audio, such as Dolby Stereo with these new systems has greatly increased the enjoyment of movie sound.

Advances in electronics technology now make it possible to bring these discrete digital audio soundtracks into your home. Many of today's new LD players and an increasing number of LD movie releases provide for Dolby Digital soundtracks. In the future, high definition television (HDTV) broadcasts will also carry multichannel digital audio information.

To prevent your AVR80// from obsolescence, special jacks are provided for use with external multichannel audio adapters.

If an adapter such as the Harman Kardon ADP303 is installed in your system, connect its six analog audio outputs to the **6-CH DIRECT INPUT** jacks **Ⓞ** on the AVR80//s rear panel.

When listening to programs using an external adapter, press the **6-CH DIRECT** button **25** **21** on the remote or front panel. All surround processing will be disabled when 6 Channel Direct is in use, as none is required with discrete audio signals. Volume is controlled in the normal fashion.

**NOTE:** Audio reproduced from the 6 Channel Direct inputs may not be recorded.

# Advanced Features

32

## Surround Mode Chart

<b>MODE</b>	<b>FEATURES</b>	<b>DELAY TIME RANGE</b>
DOLBY PRO LOGIC	Dolby Pro Logic is the standard mode for surround sound decoding. It uses information encoded in a two channel stereo recording to produce four distinct channels: Left, Center, Right and Surround. Use this mode for accurate reproduction of programs bearing the Dolby Surround, DTS Stereo, UltraStereo or other "Surround" logos. Surround encoded programs include videocassette and LD movies, TV and cable programs, radio programs and audio CDs. Dolby Pro Logic processing may also be used to provide a pleasing surround effect with source material that does not carry surround encoding.	15 ms – 30 ms Initial Setting = 20 ms
THX CINEMA	THX Cinema is a patented process developed by Lucasfilm Ltd. as an enhancement to surround processing. It includes additional enhancements that greatly improve the spectral and spatial realism of motion pictures that are recorded with surround encoding. THX Cinema's exclusive processing is designed to overcome the differences in acoustics between movie theaters and home listening rooms so that movie sound tracks will sound the same way at home as they did in the mixing room where they are created. Use this mode when viewing motion pictures on video.	15 ms – 30 ms Initial Setting = 20 ms
DOLBY 3 STEREO	Dolby 3 Stereo uses the information contained in a surround encoded program to create center channel information. In addition, the information that is normally sent to the rear channel surround speakers is carefully mixed in with the front left and right channels for increased realism. Use this mode when you have a center channel speaker, but no surround speakers.	No Surround Channels
MOVIE SURROUND	Movie Surround uses decoding similar to Pro Logic, but it permits delay times up to 90 ms. Use this mode instead of Pro Logic or THX to experiment with surround times above 30 ms, or if the delay time formula suggests a larger time delay for your room.	40 ms – 90 ms Initial Setting = 20 ms
HALL SURROUND	This mode is designed for use with stereo recordings. It provides a sound field effect that simulates the complex combination of direct and reflected sounds that create the rich reverberant atmosphere of a medium sized circular concert hall.	10 ms – 90 ms Initial Setting = 20 ms
MATRIX SURROUND	This mode is designed for use with sports broadcasts, live concerts or other programs where the feeling of a wide surround effect is desired.	10 ms – 90 ms Initial Setting = 20 ms
MONO	This mode is intended for use with old movies, television shows and other programs that have a monaural sound track. All sound will be reproduced through the center channel speaker, if installed. If there is no center channel speaker, monaural sound is reproduced from the front left and right speakers.	No Surround Channels
STEREO	This mode turns off all surround processing and presents the pure left and right channel presentation of two channel stereo programs.	No Surround Channels

# Multiroom Operation

33

The AVR80// is unique among A/V receivers in that it is equipped to operate as the control center for a sophisticated multiroom operation with accessories as simple as a remote IR sensor or as sophisticated as a specialized external amplifier and a special version of the world-famous AudioAccess wall mounted keypad controls. Although some multiroom installations will require the services of a specially trained installer, it is possible for the average do it yourself hobbyist to install a simple remote room system. For additional information on using the AVR80// in multiroom installations we suggest that you contact your dealer or custom installer.

## Installation

The key to remote room operation is to link the remote room to the AVR80//'s location with wire for an infrared receiver and speakers or an amplifier.

## IR Link

The remote room IR receiver should be connected to the AVR80// via standard coaxial cable. Plug the IR connection cable into the mini jack inside the **Multi** area in the middle of the AVR80//'s rear panel. **ⓐ**

If other Harman Kardon compatible source equipment is part of the main room installation, the **REMOTE CONT. OUT** jack on the rear panel **ⓑ** should be connected to IR IN jack on the CD player or cassette deck. This will enable the remote room location to con-

trol source equipment functions as well as the remote room input and volume.

**NOTE:** All remotely controlled components must be linked together in a daisy chain. Connect the **IR OUT** jack of one unit to the **IR IN** of the next to establish this chain.

## Audio Link

Depending on the distance from the AVR80// to the remote room, two options are available.

The preferred method is to run high quality, shielded audio interconnect cable from the AVR80//'s location to the remote room. At the remote room, connect the interconnect cable to a stereo power amplifier. The amplifier will be connected to the room's speakers. No volume control is required, as the AVR80// and the remote IR link will provide that function. At the AVR80//, plug the audio interconnect cable into the **MULTI OUT** jacks **ⓑ** at the top left corner of the AVR80//'s rear panel.

**NOTE:** The remote power amplifier must have signal sensing capability or be left on constantly to assure automatic operation at the remote room.

As an alternative, the amplifier may be placed at the same location as the AVR80//, with a standard audio interconnect between the two. Speaker wires should then be run to the remote room. High quality AWG-12 speaker wire is preferred.

**IMPORTANT NOTE:** Any cables run inside walls should be CL3/FT4 rated, or carry any other certification that is required by the NEC, NFPA or state and local building and electrical codes. To avoid interference, audio and speaker cables should not be parallel to, or in the same conduits with AC cables. If you have any questions about multi-room wiring consult your dealer, custom installer or a licensed contractor or electrician.

## Set-up

Once the equipment connections have been made, the AVR80// needs to be configured for multiroom operation by following these steps:

1. Press the **SELECT** **Ⓐ** to bring the **MAIN MENU** to the screen (Figure #1). Press the **▼** button **Ⓒ** four times until the on screen **>** cursor is pointing to **MULTI ROOM SEL** and press **SELECT** **Ⓐ**. The video screen will move to the **MULTI ROOM SELECTOR** menu (Figure #17).
2. Press the **▶** button **Ⓒ** until the desired input source for the multi room system is selected.

# Multiroom Operation

3. When the source is selected, press the ▼ button until the > cursor is next to **RETURN TO MAIN MENU**. Press **SELECT**.

4. At the **MAIN MENU**, press the ▼ button once so that the > cursor is pointing to **SET UP MENU**. Press **SELECT**.

5. This will bring **SET UP MENU 1** (Figure #2) to the screen. Press the ▼ button twice until the > cursor is pointing to **GO TO SET UP MENU 2**. Press **SELECT**.

6. When **SET UP MENU 2** (Figure #3) appears, the > cursor will be pointing to **MULTI RM VOL**. Use the ◀ or ▶ buttons (17) on the remote to select one of the following choices.

a. If the remote room is equipped with a remote receiver only, volume control will be performed by the AVR80// using a remote control in the second room. For this type of control, select the **VARIABLE** option.

b. If the volume control in the remote room will be controlled by the amplifier in the remote room, or if a specialized amplifier such as the AudioAccess AVX-603 will be used, select **FIXED**.

7. After making a selection, press the ▼ button once so that the > cursor is next to **SET LEVEL**.

8. Use the ◀ or ▶ buttons (17) on the remote to establish a volume level for turn on or constant level, as determined by the previous selection.

a. If **VARIABLE** volume has been selected, this setting will determine the volume level for the remote room each time it is turned on.

b. If **FIXED** volume has been selected, this level will be the constant volume level at the remote room location unless a local volume control is installed. Set the level as close to "0dB" as possible without distorting the output signal.

9. When the level has been entered, press the ▼ button so that the > cursor is pointing to **RETURN TO MAIN MENU** and press **SELECT**.

10. At the **MAIN MENU**, use the navigational arrow buttons on the remote to exit from the main system.

The AVR80// is now configured for multi room operation.

## Operation

Multi room operation is simple, and it may be controlled from either the main listening room where the AVR80// is located, or from a remote room where an IR receiver or AudioAccess keypad has been installed.

## Main Room Operation

In this option, the remote room feed is controlled from the main listening room using the AVR80//s front panel controls.

To activate the remote room feed, press the **MULTI** button on the front panel (9). This will send the signal of the AVR80//s currently selected input source to the remote room at the volume level established in **SET UP MENU 2**.

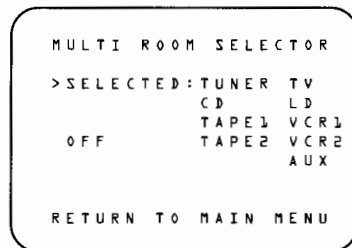

Figure 17

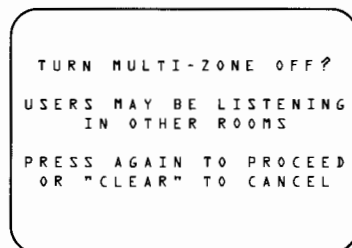

Figure 18

# Multiroom Operation

35

The **MULTI** indicator on the front panel display **10** will flash to indicate that the multiroom system is turned on in the variable mode, and that Source Linking is in effect. With Source Link, any change to the AVR80//s input selection will also change the feed to the remote room locations. If the input source is changed from the remote room, the **MULTI** indicator will remain lit, but stop flashing.

If the AVR80// is turned off in the main listening room, the feed to the remote room will continue, although the **MULTI** indicator will now remain constantly illuminated.

To turn off the feed to the remote room either while the AVR80// is still on, or after it is turned off, press the **MULTI** button on the front panel. If the **MULTI** button is pressed while the AVR80// is still on and the on screen video system is engaged, a warning message will appear on the video display (Figure #18) to remind you that people may still be lis-

tening to the system in the remote room location.

## Remote Room Operation

In this option, the remote room feed is controlled by the use of an AVR80// compatible remote control. The remote commands must be transmitted to the AVR80// via a coaxial link connected to the **MULTI** input on the AVR80//s rear panel.

Using the remote control in the second room press the **POWER ON** button to turn on the remote room feed. This will activate the multi room portion of the AVR80// whether or not it may be on in the main listening room.

The initial feed to the remote room will be the last station selected by the tuner. Any other AVR80// input source may subsequently be selected using the source buttons on the remote control.

The initial volume at the remote room will be the level established using the options in **SET UP MENU 2**.

If IR connections have been made to the source playback equipment, it is also possible to control the functions of those units via the second room remote. Consult with your dealer or custom installer for additional information on this type of installation.

When the remote room is controlling the AVR80// via the IR link, the **MULTI** indicator on the AVR80//s front panel will remain constantly lit.

**NOTE:** Whenever the AVR80// is in a multiroom mode, the **MULTI** indicator will flash briefly whenever a command is transmitted by the remote room location and received by the AVR80//.

---

## Memory Backup

This product is equipped with a memory backup system that preserves tuner presets and system configuration information if the unit is accidentally unplugged or subject to a power outage. This memory will last for approximately one week, after which time all information must be re-entered.

## System Reset

In the rare case where the unit's operation or the displays seem abnormal, the cause may involve the erratic operation of the system's memory or microprocessor.

To correct this problem, first unplug the unit from the AC wall outlet and wait at least three minutes. After the pause, reconnect the AC power cord and check the unit's operation. If the system still malfunctions, a system reset may clear the problem.

To clear the entire system memory of the unit, press and hold the **MEMO 24** and **CLEAR 25** buttons until **CLEAR MEMO** appears in the front panel display. Release the buttons and note that the unit will turn off. Remember that once you have cleared the memory in this

fashion it will be necessary to re-establish all system configuration information and tuner presets.

If the system is still operating incorrectly, there may have been an electrostatic discharge or severe AC line interference that has corrupted the memory or microprocessor.

If a reset does not solve the problem, consult an authorized Harman Kardon service depot.

# Troubleshooting

36

## Troubleshooting Chart

<i><b>SYMPTOM</b></i>	<i><b>CAUSE</b></i>	<i><b>SOLUTION</b></i>
No front panel lights when power switch is pressed	<ul style="list-style-type: none"><li>• No AC Power</li></ul>	<ul style="list-style-type: none"><li>• Make certain AC power cord is plugged into a live outlet.</li><li>• Check to see if outlet is switch controlled.</li></ul>
Display lights, but no sound or picture	<ul style="list-style-type: none"><li>• Intermittent input connections</li><li>• <b>MUTE</b> is on</li><li>• Volume control is down</li></ul>	<ul style="list-style-type: none"><li>• Make certain that all input and speaker connections are secure.</li><li>• Press <b>MUTE</b> button.</li><li>• Turn up volume control.</li></ul>
No sound from any speaker. Light around power switch is red.	<ul style="list-style-type: none"><li>• Amplifier is in protection mode due to possible short.</li><li>• Amplifier is in protection mode due to internal problems.</li></ul>	<ul style="list-style-type: none"><li>• Check speaker wire connections at receiver and speaker ends for shorts.</li><li>• Contact your local Harman kardon service depot.</li></ul>
No sound from surround or center speakers	<ul style="list-style-type: none"><li>• Incorrect surround mode</li><li>• Input is monaural</li><li>• Incorrect configuration</li></ul>	<ul style="list-style-type: none"><li>• Select a mode other than Stereo or Monaural.</li><li>• There is no surround information from mono sources.</li><li>• Check configuration in <b>SET UP MENU 1</b>.</li></ul>
No On Screen Control Menus	<ul style="list-style-type: none"><li>• TV input is "S" Video</li></ul>	<ul style="list-style-type: none"><li>• Change TV input to Composite Video. The menus are available <b>ONLY</b> on Composite Video.</li></ul>
Unit does not respond to remote commands	<ul style="list-style-type: none"><li>• Weak batteries in remote</li><li>• Remote is in <b>LEARN</b> position</li><li>• Remote sensor is obscured</li></ul>	<ul style="list-style-type: none"><li>• Change remote batteries.</li><li>• Slide <b>USE/LEARN</b> switch to <b>USE</b>.</li><li>• Make certain front panel sensor is visible to remote.</li></ul>
Intermittent buzzing in tuner	<ul style="list-style-type: none"><li>• Local interference</li></ul>	<ul style="list-style-type: none"><li>• Move unit or antenna away from computers, fluorescent lights, TVs, motors or other electrical appliances.</li></ul>

# Technical Specifications

37

## Audio Section

Stereo Mode

Continuous Average Power (FTC)

100 Watts per channel 20Hz–20kHz,  
@ < 0.07% THD, both channels driven into 8 Ohms

Five Channel Surround Mode

Continuous average power per channel (FTC)

Front L&R channels:  
85 Watts per channel from 20Hz–20kHz,  
@ < 0.05% THD, both channels driven into 8 Ohms

Center channel:  
85 Watts from 20Hz–20kHz,  
@ < 0.05% THD, driven into 8 Ohms

Surround channels:  
60 Watts per channel from 40Hz–20kHz,  
@ < 0.05% THD, both channels driven into 8 Ohms

Input Sensitivity/Impedance

Linear	220mV/50 Kohms
Front Main In	1.5 V/20 Kohms
Center Main In	1.5 V/20 Kohms
Surround Main In	1.0 V/20 Kohms

Signal to Noise Rate (IHF-A)

Linear 95 dB

Dolby Surround

Channel Separation 40dB

Frequency Response

@ 1W (+0, -3dB) 7Hz–80kHz

High Instantaneous

Current Capability (HCC) ±45 amps

Transient Intermodulation

Distortion (TIM) Unmeasurable

Rise Time

16 µsec

Slew Rate

40 V/µsec

## FM Tuner Section

Frequency Range	87.5–108.0 MHz
Usable Sensitivity	IHF 1.3 µV/13.5 dBf
Signal to Noise Ratio	Mono/Stereo 76/68 dB
Distortion	Mono/Stereo 0.2/0.5%
Stereo Separation	1 kHz 40dB
A.C.S.	±400kHz 65dB
Image Rejection	98MHz 50dB
Tuner Output Level	1kHz, ±75kHz Dev 800mV

## AM Tuner Section

Frequency Range	520–1710 kHz
Signal-to-Noise Ratio	50dB
Usable Sensitivity	Loop 500 µV
Distortion	1kHz, 30% Mod 0.5%
Selectivity	±20kHz 70dB

## Video Section

Television Format	NTSC
Input Level/Impedance	1Vp-p/75ohms
Output Level/Impedance	1Vp-p/75ohms
Video Frequency Response	10Hz to 8MHz (-3dB)
S/N	65dB

## General

Power Requirement	AC 120V 60Hz
Power Consumption	54W idle, 700W maximum
Dimension (Max)	
Width	17.4 inches (444 mm)
Height	6.4 inches (160 mm)
Depth	18 inches (459 mm)
Weight	31 lbs. (14 kg)

All features and specifications are subject to change without notice.

Manufactured under license from Dolby Laboratories Licensing Corporation.

Additionally licensed under Canadian patent number 1,037,877.

"Dolby," "Pro Logic," the double-D symbol and "AC-3" are registered trademarks of Dolby Laboratories Licensing Corporation.

Manufactured under license from Lucasfilm Ltd. U.S. patent numbers 5,043,970; 5,189,703; and 5,222,059. Foreign patents pending. THX and Home THX are registered trademarks of Lucasfilm Ltd.

DTS is a trademark of Digital Theater Systems

SDDS is a registered trademark of Sony Corp.